



---

BE PAYMENT READY

# Moneris<sup>®</sup> iCT250

## Reference Guide





---

**BE PAYMENT READY**

## Need help?

**Web:** [moneris.com/support](https://moneris.com/support)

**Toll-free:** 1-866-319-7450

Record your Moneris merchant ID here:

---

# Contents

<b>Setting up Your Terminal</b> .....	<b>5</b>
<b>Before you get started</b> .....	<b>6</b>
<b>Hardware setup</b> .....	<b>8</b>
What to do next .....	12
<b>Communications setup</b> .....	<b>13</b>
Using dynamic IP .....	13
Using static IP .....	13
Using dial .....	15
Using dial backup (optional) .....	15
Setting a dial prefix .....	15
Communications troubleshooting .....	16
<b>Initialization and logon</b> .....	<b>18</b>
<b>Additional options</b> .....	<b>19</b>
Enabling the external PINpad (if attached) .....	19
Printing the contactless logo on contactless transaction receipts .....	20
Enabling Tip Entry, Cashback, or Invoice Number .....	20
Changing printer options .....	20
Changing the terminal language .....	21
Enabling the admin password for manual entry protection .....	21
Enabling loyalty and gift cards .....	22
Enabling tip entry (gift cards) .....	22
<b>Using Your Terminal</b> .....	<b>23</b>
<b>Moneris iCT250</b> .....	<b>24</b>
Terminal keys and hardware .....	25
<b>Optional external PINpad</b> .....	<b>26</b>
General guidelines for the iPP320 PINpad .....	26
<b>Card types</b> .....	<b>27</b>
Magnetic stripe card .....	27
Chip card .....	27
Contactless card .....	27
<b>Cardholder verification</b> .....	<b>28</b>
Cardholder verification methods (CVM) .....	28
Cardholder verification limit .....	28
<b>Card entry options</b> .....	<b>29</b>
Insert: Chip cards .....	29
Wave/Tap: Contactless cards .....	29
Contactless Transaction Limit (CTL) .....	30
Swipe: Magnetic stripe cards .....	30

Manual card entry .....	30
<b>Transactions.....</b>	<b>31</b>
General guidelines.....	31
Admin code shortcuts.....	31
Purchase [100].....	32
Partially approved Purchase.....	32
Refund [101] / VOID–Purchase [106] / VOID–Refund [107] .....	32
Pre-Authorization [102].....	32
Cheque Authorization [105] .....	33
Advice using Sequence Number [103] / Force Post [103].....	33
Advice List [109] .....	33
Balance Inquiry [110].....	34
Prompts without tip entry .....	34
Merchant prompts: Purchases/Pre-Auths/Refunds/Voids.....	34
Merchant prompts: Cheque Authorizations.....	36
Merchant prompts: Advices/Force Posts .....	36
Customer prompts: On the terminal .....	38
Customer prompts: On the PINpad .....	40
Prompts with tip entry .....	41
Merchant prompts: Purchase with tip enabled.....	41
Customer prompts on the terminal: Purchase with tip entry enabled.....	42
Customer prompts on the PINpad: Purchase with tip enabled .....	44
<b>Receipts .....</b>	<b>46</b>
Signing credit card receipts .....	46
Reprinting receipts .....	46
Card masking .....	46
Contactless transactions.....	47
Receipt samples.....	47
Pre-Auth receipt sample.....	47
Original receipt sample.....	47
Partial Approval receipt sample.....	48
<b>Reports .....</b>	<b>49</b>
Masking on reports.....	49
Reprint merchant receipt [66].....	49
Clerk subtotals report [82] .....	49
Current batch totals report [99] .....	50
Merchant sub-totals report [95].....	50
Pre-auth list [62] .....	50
Balance inquiry report [94].....	51
Configuration report [16] .....	51
Tip totals report [96] .....	51
<b>Admin functions.....</b>	<b>52</b>
Logon [02].....	52
Logoff [03] .....	52
Re-initialization [01] .....	52

<b>End-of-day process .....</b>	<b>53</b>
Merchant close .....	53
System close .....	54
<b>Troubleshooting .....</b>	<b>55</b>
Error messages .....	55
Equipment issues.....	59
<b>Merchant support.....</b>	<b>60</b>

This page left blank intentionally.



# Setting up Your Terminal

In this section, we go over everything you need to know to set up your Moneris iCT250.

You can also view our setup videos online at [moneris.com/support-iCT250](https://moneris.com/support-iCT250).

## Before you get started

1. Please confirm that you received all the necessary items in your Welcome Kit.

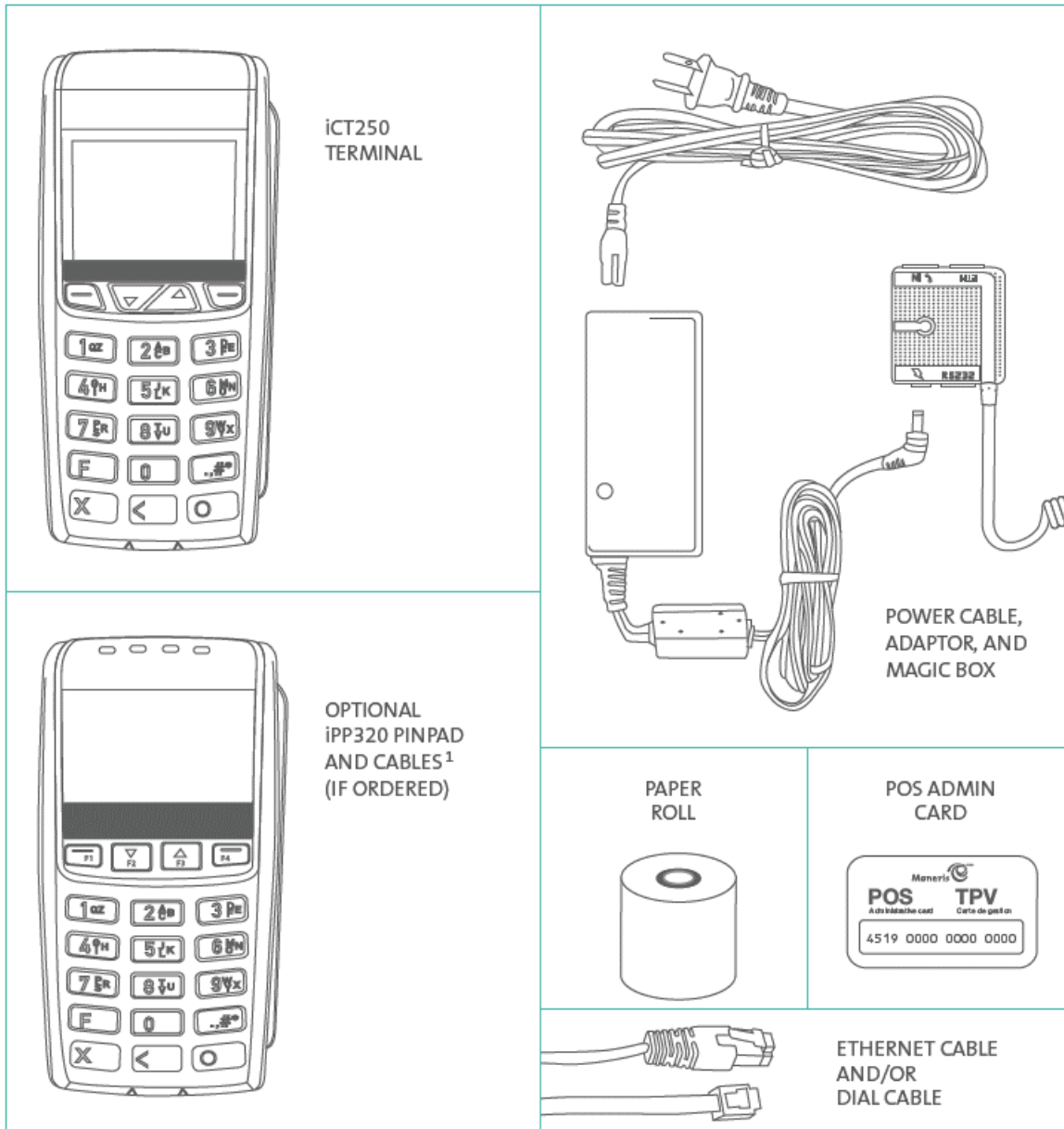

<sup>1</sup>If you are setting up the terminal to work as a semi-integrated device with your electronic cash register (ECR), please note that the iPP320 PINpad is not supported (i.e., a semi-integrated terminal cannot be used in conjunction with an attached iPP320 PINpad).

2. If your terminal will communicate with the Moneris host over high-speed Ethernet, review the **Moneris IP Readiness Checklist** (available at [moneris.com/checklist](https://moneris.com/checklist)) to ensure that your Ethernet service is ready to support your terminal.



3. Make sure you have the following information:

- Your 13-digit Moneris **Merchant ID** (found in your “Important information” email).
- Settlement responsibility (found in your Welcome Email): **System Close** (Moneris closes your batch at the end of each day) or **Merchant Close** (you are responsible for closing your batch at the end of each day).
- Optional features e.g. **gift cards, loyalty cards, Ernex Terminal ID** (found in your Moneris Gift & Loyalty Welcome letter).

If any of the above required elements are missing, please call Moneris Customer Care toll-free at [1-866-319-7450](tel:1-866-319-7450).

4. Do one of the following:

- **If you are setting up a standalone terminal** (with or without an external iPP320 PINpad): Proceed to Hardware setup on page 8.
- **If you are setting up a semi-integrated terminal** to work with your electronic cash register (ECR): Refer to the *Moneris iCT250 Semi-Integrated Reference Guide* available at [moneris.com/support-iCT250](https://moneris.com/support-iCT250), and follow the instructions in the IMPORTANT: READ FIRST section of that guide.

# Hardware setup

Follow these instructions to set up your terminal hardware. If your location does not have Ethernet networking, skip to step 2 to setup a dial connection.

## 1 Hi-Speed Ethernet setup

- a. Plug one end of the Ethernet cable into the Magic Box port labelled ETH.

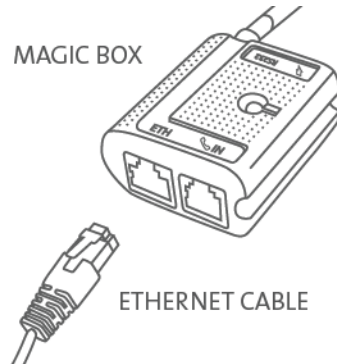

- b. Plug the other end of the Ethernet cable into the router/switch/hub/internal wiring — whatever is applicable to the high-speed Internet service at your location. (If necessary, please refer to the Moneris **IP Readiness Checklist** available at [moneris.com/checklist](http://moneris.com/checklist).)

**Recommendation:** Set up dial backup as well (follow the Dial backup instructions on page 15) so that the terminal can use dial backup if your Internet service is temporarily unavailable.

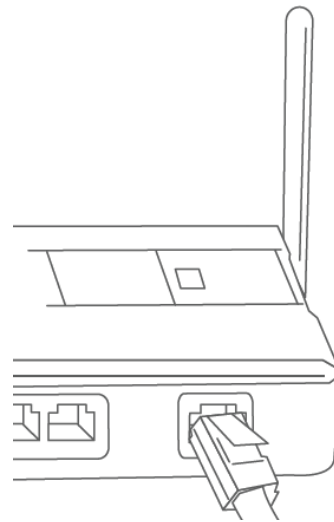

## 2 Dial / Dial Backup setup (optional)

- a. Plug one end of the dial cable into the Magic Box port labelled “ IN”.

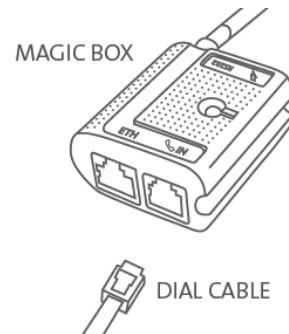

- b. Plug the other end of the dial cable into an analog phone jack.

**Recommendation:** Use a dedicated phone line for the terminal. Sharing the line with another device (e.g., a fax machine) can cause communication problems.

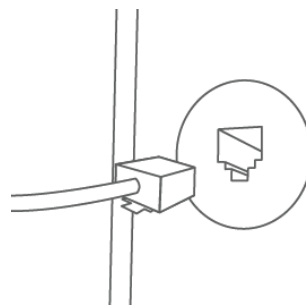

- c. Do one of the following:

- If you ordered an external PINpad, go to step 3, “Connect the external iPP320 PINpad” on page 9.
- If you did not order an external PINpad, go directly to step 4, “Connect the two-part power supply cable” on page 11.

## 3 Connect the external iPP320 PINpad (optional)

- a. Turn the PINpad over so that the back panel is facing you.
- b. Plug the PINpad cable into the USB port on the PINpad (raise the latch).
- c. Fold the latch down and press to secure the cable.

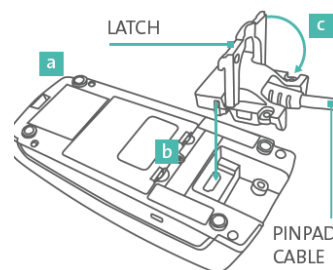

- d. Turn the terminal over so that the back panel is facing you. Locate the two corner latches.

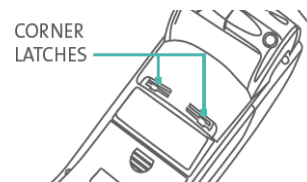

### 3 Connect the external iPP320 PINpad (optional)

- e. Grip the latches simultaneously, and then pull back to raise the back panel.
- f. Detach the panel completely.

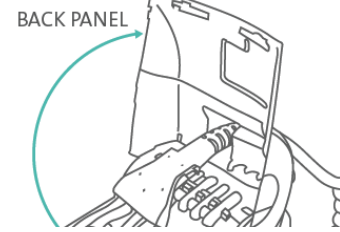

- g. If a three-pronged rubber stopper is attached, go to step h. If there is no stopper, go to step i.
- h. Grip the stopper, and pull back until it tears off completely (or use scissors to carefully snip it off).

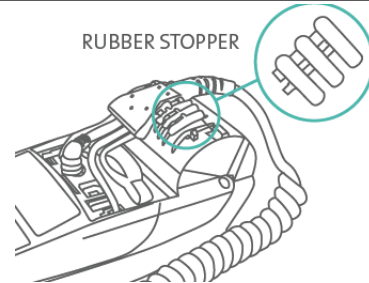

- i. Plug the PINpad cable into the port labelled USB HOST in the terminal compartment.
- j. Position the PINpad cable so that it sits securely in the middle groove at the top of the terminal.

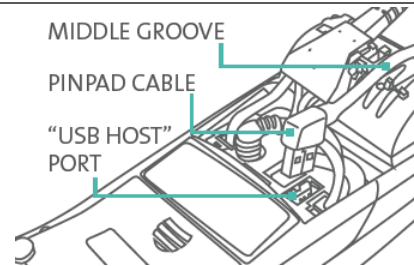

- k. Position the back panel so that its upper two corner tabs are slotted into the openings at the top of the terminal.

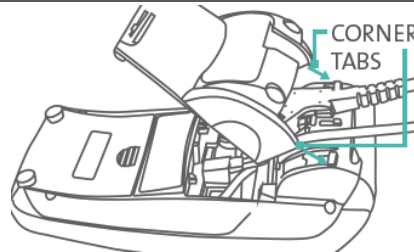

- l. Close the back panel until it snaps shut. (The PINpad cable should be secured as it passes through the middle opening between the closed panel and the terminal.)
- m. Go to step 4 below.

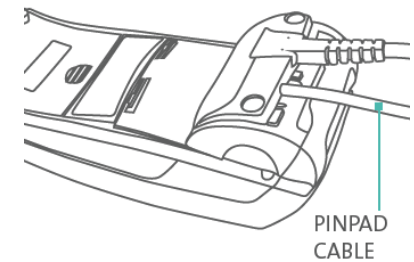

## 4

## Connect the two-part power supply cable

- a. Insert the plug connector into the adaptor box to form the complete power cable.
- b. Insert the power cable's barrel connector into the Magic Box's circular port labelled with the power symbol .

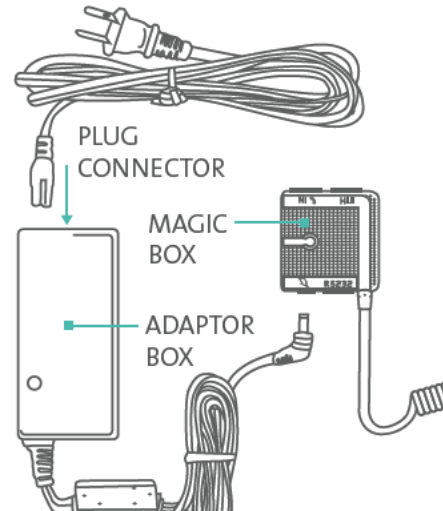

- c. Plug the other end of the power cable into a power source. The terminal (and external iPP320 PINpad if attached) will power on.

**Recommendations:** Always plug the power cable into the power source last to avoid power surges. Use a power bar equipped with surge protection if possible. Do not use the power cable from your existing terminal, as it may damage your new terminal.

**IMPORTANT:** You must use the exact power adaptor and cables provided by Moneris to work with the Moneris iCT250 terminal. Failure to do so may affect the operability of, or cause damage to, the equipment.

- d. Wait for the terminal to display TERMINAL SETUP REQUIRED.
  - If you attached an external PINpad, wait for it to display the CPX version screen as shown here.
- e. Go to step 5, "Install the paper roll" on page 12.

CPX##.##

<RS232>

#####

#####

## 5 Install the paper roll

- a. Lift the printer latch up, and then pull back to open the lid and expose the paper well.

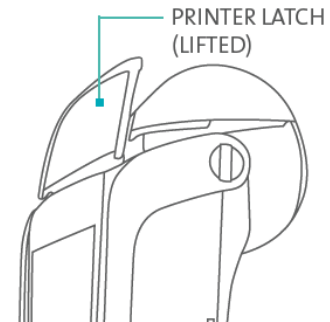

- b. Insert the paper roll into the paper well with the loose end unrolling from the bottom of the roll towards the front of the terminal.
- c. Unroll enough paper to extend at least one inch (2.5 cm) past the faceplate.

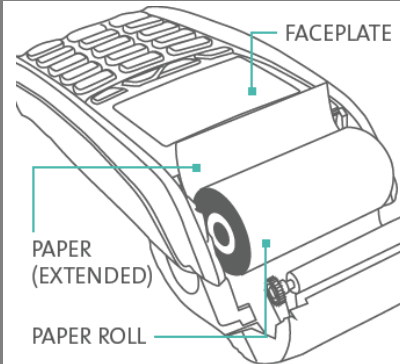

- d. Close the lid, and press down to snap it back into place so that the extended paper is pressed securely against the closed lid and the faceplate.

**Note:** To advance the paper from the printer when the lid is closed, you must press and hold down the yellow  key when the terminal is powered on. DO NOT attempt to manually advance the paper by pulling it as this will damage the printer.

## What to do next

Your hardware setup is complete. The next step is to configure the terminal, and the external PINpad if applicable. Choose one of the options below.

If you are setting up the terminal to work as:



- a standalone device with an external PINpad, proceed to *Enabling the external PINpad* on page 19;
- a standalone device without an external PINpad, proceed to *Communications setup* on page 13;
- a semi-integrated device with your ECR, refer back to the ***Moneris iCT250 Semi-Integrated Reference Guide***, and continue the applicable overview setup procedure beginning at step 3, “Enable Semi-Integrated mode on the terminal...”.

## Communications setup

Your terminal must be configured to communicate with the Moneris host.

1. Do one of the following based on your requirements:
  - If you are using dynamic IP as default, proceed to *Using dynamic IP* below.
  - If you are using static IP as default, proceed to *Using static IP* on page 13.
  - If you are using dial as default, proceed to *Using dial* on page 15.
  - If you are using dial as backup, proceed to *Using dial as backup* on page 15.

### Tips for moving through the menus

- Press the  key to answer "yes" to any questions or to scroll down.
- Press the  key to answer "no" or to scroll up.
- Press the green  key to select a menu item or finish entering information and move on to the next step.

## Using dynamic IP





The terminal is already configured for dynamic IP communications.

1. Do one of the following:
  - If you are using dial backup and need to enter a prefix (e.g., 9) to connect to an outside line, proceed to *Setting a dial prefix* on page 15.
  - If you are not using dial backup or you are but do not need to enter a prefix, proceed to *Initialization and logon* on page 18.



## Using static IP

















Contact your Internet Service Provider (ISP) to gather the following information: the terminal's IP address, Mask ID, Gateway address, and DNS addresses.

**Note:** *If you are configuring the terminal to work as a semi-integrated device with your ECR, you will also need to know the port number that the ECR is configured to use to communicate with the terminal.*

1. Press the  key twice, key in **13**, and press the green  key.
2. Press the green  key to select **TERMINAL SETUP**.
3. Press the green  key to select **TERMINAL TYPE**.
4. Scroll up to **STATIC**, and press the green  key.
5. When the TERMINAL SETUP menu appears, enter the static IP information as follows:

**Note:** *To enter a decimal point, press the 0 (zero) key and then press the  key.*





- a. Scroll down to TERMINAL ADDR, and press the green  key. Then key in the terminal's IP address, and press the green  key.

- b. Scroll down to MASK ID, and press the green  key. Then key in the terminal's Mask ID, and press the green  key.
  - c. Scroll down to GATEWAY, and press the green  key. Then key in the terminal's Gateway address, and press the green  key.
  - d. Do one of the following:
    - **If you are setting up a standalone terminal (with or without an external PINpad):** Skip this step, and go directly to step 6.
    - If you are setting up the terminal to work as a semi-integrated device with your ECR: Scroll down to **PORT NUMBER**, and press the green  key. Then key in the port number that the ECR is using to communicate with the terminal, and press the green  key.
6. Press the red  key once to return to the ETHERNET SETUP menu.
  7. Enter the terminal's DNS address information:
    - a. Scroll down to **DNS SETUP**, and press the green  key.
    - b. Scroll down to **PRIM ADDRESS**, and press the green  key. Key in the terminal's Primary DNS Address, and press the green  key.
    - c. Scroll down to **SEC ADDRESS**, and press the green  key. Key in the terminal's Secondary DNS Address, and press the green  key.
  8. Press the red  key twice.  
The REBOOT TERMINAL message appears, and then the terminal reboots.
  9. When the terminal displays TERMINAL SETUP REQUIRED or REINITIALIZATION REQUIRED, go to the next step.
  10. Press the  key twice, key in 13, and press the green  key.
  11. When the ETHERNET SETUP menu appears, press the red  key once.
  12. When the terminal displays TCP HOST CONNECTION OK PRESS OK, press the green  key.
    - If TCP CONNECTION FAILED or HOST CONNECTION FAILED appears, see page 16 for troubleshooting.
  13. When the terminal displays TERMINAL SETUP REQUIRED or REINITIALIZATION REQUIRED, do one of the following:
    - If you are using dial backup and need to enter a prefix (e.g., 9) to connect to an outside line, proceed to *Using dial backup* on page 15.
    - If you are not using dial backup or you are but do not need to enter a prefix, proceed to *Initialization and logon* on page 18.



## Using dial





To set up dial as your default method of communicating with the Moneris host, follow these steps.

1. Press the  key twice, key in **08** and, press the green  key.
2. Press the green  key to select **COMMS TYPE**.
3. Scroll up to **DIAL**, and press the green  key.
4. When the **GENERAL PARAMETERS** menu appears, press the red  key two times.  
The **TERMINAL SETUP REQUIRED** or **REINITIALIZATION REQUIRED** message appears.
5. Do one of the following:
  - If you need to enter a prefix (e.g., 9) to connect to an outside line, follow the steps under *Setting a dial prefix* on this page.
  - If you do not need to enter a prefix, proceed directly to *Initialization and logon* on page 18.

## Using dial backup (optional)

If you do not need to enter a prefix (e.g., 9) to connect to an outside line, proceed directly to *Initialization and logon* on page 18. If you do need to enter a prefix to connect to an outside line, follow the steps under *Setting a dial prefix* (directly below).

### Setting a dial prefix

1. Press the  key twice, key in **15**, and press the green  key.
2. Press the green  key to select **PREFIX**.
3. Key in the prefix number (e.g. 9), and press the green  key.
4. Press the red  key twice.

When the terminal displays **TERMINAL SETUP REQUIRED** or **REINITIALIZATION REQUIRED**, proceed to *Initialization and logon* on page 18.

## Communications troubleshooting











Error Message	Solution
<p><b>HOST CONNECTION FAILED</b></p> <p>or</p> <p><b>TCP CONNECTION FAILED</b></p>	<p>The terminal cannot establish a connection to the Moneris host.</p> <p><b>If the terminal is configured for IP:</b></p> <ol style="list-style-type: none"> <li>1. Press the green  key to return to the TERMINAL SETUP REQUIRED screen.</li> <li>2. Confirm that the Ethernet cable is securely plugged into the ETH port located on the Magic Box. Refer to <i>High-Speed Ethernet</i> setup on page 8.</li> <li>3. Confirm that the router and hub/switch (if any) are functioning (refer to the Moneris <b>IP Readiness Checklist</b> at <a href="http://moneris.com/checklist">moneris.com/checklist</a> to confirm that your firewall rules have been updated).</li> <li>4. Confirm that the network is functioning. <ul style="list-style-type: none"> <li>▪ Public Internet: Contact your ISP (Internet service provider) for assistance.</li> <li>▪ Corporate WAN: Call your corporate help desk to confirm that the corporate WAN is functioning properly.</li> </ul> </li> <li>5. Once you have confirmed that your network is functioning: Press the  key twice, key in 11, and press the green  key.</li> <li>6. When the HOST SETUP menu appears, press the red  key once.</li> <li>7. Do one of the following depending on what appears: <ul style="list-style-type: none"> <li>▪ If TCP HOST CONNECTION OK PRESS OK appears, press the green  key. Go to step 8.</li> <li>▪ If the TCP CONNECTION FAILED error recurs (static IP configuration only): <ol style="list-style-type: none"> <li>a. Press the  key twice, key in 13, and press the green  key.</li> <li>b. Press the green  key to select TERMINAL SETUP.</li> <li>c. Re-enter the static IP values. Go back to <i>Using static IP</i> (page 13), and continue at step 7.</li> </ol> </li> </ul> </li> </ol>





Table continues on the next page.

Error Message	Solution
	<p>8. Do one of the following:</p> <ul style="list-style-type: none"> <li>▪ If you are using dial backup and need to enter a prefix (e.g., 9) to connect to an outside line, proceed to <i>Setting a dial prefix</i> on page 15.</li> <li>▪ If you are not using dial backup or you are but do not need to enter a prefix, proceed to <i>Initialization and logon</i> on page 18.</li> </ul> <p><b>If the terminal is configured for dial:</b></p> <ol style="list-style-type: none"> <li>1. Press the green  key to return to the TERMINAL SETUP REQUIRED screen.</li> <li>2. Confirm that the dial cable is securely plugged into the  IN” port located on the Magic Box.</li> <li>3. Confirm that the COMM TYPE is set to DIAL. Refer to <i>Using dial</i> on page 15.</li> <li>4. If the terminal must use a prefix to dial out, ensure that the dial PREFIX parameter has been configured correctly. Refer to <i>Setting a dial prefix</i> on page 15.</li> <li>5. Return to <i>Initialization and logon</i> on page 18.</li> </ol>

# Initialization and logon

Before processing any transactions, you must initialize your terminal with the Moneris host and logon.

1. Do one of the following:
  - **If you are setting up a standalone terminal** (with or without an external PINpad): Go directly to step 2.
  - **If you are setting up a semi-integrated terminal** to work with your ECR: Refer back to your *Moneris iCT250 Semi-Integrated Reference Guide*, and continue the applicable overview setup procedure beginning at step 5 ("Configure the terminal-to-ECR communications parameters...").

2. Press the  key twice, key in 01, and press the green  key.
3. When MERCHANT ID appears, key in your current 13-digit merchant ID, and press the green  key.
4. When PHONE NUMBER appears, key in the number as follows, and press the green  key.

If your merchant ID begins with:	Key in:
00301	1 888 699 7299
00302	1 888 358 8602
00304	1 888 332 8433

5. Wait while the terminal communicates with the Moneris host. Over the next few moments, the screen will display SENDING, RECEIVING, and PROCESSING.
  - If SWIPE ADMIN CARD appears, swipe one of the white POS Admin cards (provided with your new terminal).
6. Wait while the terminal communicates with the Moneris host to log on.
7. If the initialization and logon are successful, the terminal screen should display one of the following READY screens (which will always display when your terminal is ready to be used):
  - **Standalone terminal:**  
PURCHASE ENTER AMOUNT appears on the terminal. (If an external PINpad is attached, WELCOME/BONJOUR appears on the PINpad.)
  - **Semi-integrated terminal:**  
WELCOME/BONJOUR appears on the terminal.
8. If you need to advance the paper from the printer, you must press and hold down the yellow  key when the terminal is powered on.

**Note:** Once the paper roll is installed and the printer lid is closed, DO NOT attempt to manually advance the paper by pulling it as this will damage the printer.
9. Your terminal is ready to process transactions.

## Additional options





There are several options that you can choose to enable on your terminal to enhance its functionality.





**Note:** All instructions in this section begin at the terminal's READY screen.

### Enabling the external PINpad (if attached)

**Important:** If you are setting up your terminal as a semi-integrated device to work with your ECR, do not follow these steps to enable an external PINpad. The PINpad option is not supported in Semi-Integrated mode.





1. Unplug the terminal's power cable from the power source and then replug it to restart the hardware.
2. On the PINpad, do the following:

a. As soon as the PINpad displays the CPX version screen, press the green  key within 3 seconds.	<pre>CPX###.## &lt;RS232&gt; ?#####</pre>
b. When the PIN/CARD BEEP screen appears, go to the next step. <b>Note:</b> If this screen does not appear, repeat step 1.	<pre>PIN/CARD BEEP MID TONE CORR = EDIT CAN/OK = EXIT &gt;</pre>
c. Press the  key until the COM PORT screen appears.	<pre>COM PORT RS232 CORR = EDIT CAN/OK = EXIT &gt;</pre>
d. Press the yellow  key until USB-9600 appears. e. Press the green  key to select USB-9600.	<pre>COM PORT USB-9600 CORR = EDIT CAN/OK = EXIT &gt;</pre>
f. When the PINpad displays the CPX version screen, go to the next step.	<pre>CPX###.## &lt;USB-9600&gt; #####</pre>









3. On the terminal, do the following:
  - a. Press the  key twice, key in **08**, and press the green  key.
  - b. Scroll up to **EXT PINPAD**, and press the green  key.
  - c. When **ENABLE EXTERNAL PINPAD?** appears, press the  key (YES).
4. Wait for the PINpad to display WELCOME/BONJOUR.
5. When the terminal displays **TERMINAL SETUP REQUIRED**, proceed to *Communications setup* on page 13.

## Printing the contactless logo on contactless transaction receipts

When this feature is enabled, the contactless logo will be printed on all contactless transaction receipts.

1. Press the key twice, key in **08**, and press the green  key.
2. Scroll up to **CTLS LOGO**, and press the green  key.
3. Scroll to **ENABLE**, and press the green  key.
4. Press the red  key twice to return to the READY screen.

## Enabling Tip Entry, Cashback, or Invoice Number

1. Press the  key twice, key in **08**, and press the green  key.
2. Use the  key to scroll down to the option that you want to enable (e.g. TIP ENTRY, CASH BACK or INVOICE NUMBER), and press the green  key.
  - If you are enabling tip entry, follow these additional steps:
    - a. Scroll to a tip entry type (TIP BY AMOUNT or TIP BY PERCENT or TIP BY \$ AND % ), and press the green  key.
    - b. Press the red  key once, and then go to step 4.
3. Enable the option by pressing the  key (YES).
4. Press the red  key twice to return to the READY screen.





**Note:** To change the default values for the tip and cash back options, or to enable enhanced tip prompting, refer to the **iCT250 Operating Manual** in WebHelp format at [moneris.com/support](https://moneris.com/support).



## Changing printer options

The printer is set up to automatically print the second receipt 10 seconds after it prints the first receipt.

**Note:** If you don't want to wait, simply press the green  key to print the second receipt immediately.





To change this setting:

1. Press the  key twice, key in **14**, and press the green  key.
2. Scroll down to **PRINT DELAY**, and press the green  key.
3. Key in the number of seconds that the printer should wait before automatically printing the second receipt and press the green  key.

**Note:** If you key in **99**, the printer will always wait until the green  key is pressed before printing the second receipt.
4. Press the green  key to return to the PRINTER CFG menu.
5. Press the red  key twice to return to the READY screen.







**Note:** Shop for point-of-sale supplies and paper online at [shop.moneris.com](https://shop.moneris.com).

## Changing the terminal language

1. Press the  key twice, key in **04**, and press the green  key.
2. Scroll to a language, and press the green  key.
3. Press the red  key twice to return to the READY screen.

## Enabling the admin password for manual entry protection







This parameter protects the manual entry of card information on the terminal keypad. By default, a POS Admin card (shipped with your terminal) must be swiped any time card information is manually entered in order to continue the transaction. Moneris recommends that you change this parameter by setting up an admin password to be entered instead of swiping the POS Admin card. To change this parameter and set up an admin password, follow these steps.

1. Decide on your password:
  - It must be 5 to 10 numbers.
  - You cannot use consecutive numbers such as 12345 or 98765, or repeating numbers such as 22233.
  - You will have 60 seconds to enter it.
2. From the READY screen, press the  key twice, key in **22**, and press the  green key.
3. When SWIPE ADMIN CARD appears, swipe your POS Admin card.  
The ENABLE PSWD? prompt appears.
4. Select **YES** by pressing the  key.  
The ENTER NEW 5-10 DIGIT ADMIN PSWD prompt appears.  
**Note:** *You have 60 seconds to enter the password.*
5. Key in the password you decided on in step 1, and press the green  key.  
The RE-ENTER NEW ADMIN PASSWORD prompt appears.
6. Key in the password again and press the green  key.  
The message ADMIN PASSWORD SET UP SUCCESSFULLY appears briefly on the terminal, followed by the SECURITY menu.
7. To return to the READY screen, press the red  key twice.





*For instructions on how to change the password after you have set it up or what to do if the password is locked, refer to the **iCT250 Operating Manual** in WebHelp format at [moneris.com/support](https://moneris.com/support).*

## Enabling loyalty and gift cards

Didn't order a loyalty program and gift cards but would like to find out more? Please call us at **1-866-319-7450**.

1. Press the  key twice, key in **310**, and press the green  key.
2. Press the green  key to select **ENABLE ERNEX**.
3. Press the  key to select **YES**.
4. Press the green  key to select **INITIALIZATION**.
5. Key in the Ernex Terminal ID and press the green  key.
6. Wait while the terminal communicates with the Moneris host.
  - If **CLEAR TERMINAL STORAGE?** appears, press the  key to select **YES**.
7. The **READY** screen appears.
8. Your terminal is ready to process loyalty card and gift card transactions. For instructions on performing:
  - gift card transactions, refer to the ***Moneris iCT250 Gift Card Program Reference Guide***.
  - loyalty card transactions, refer to the ***Moneris iCT250 Loyalty Programs Reference Guide***.

## Enabling tip entry (gift cards)

1. Press the  key twice, key in **310**, and press the green  key.
2. Scroll down to **TIP ENTRY**, and press the  green key.
3. Press the  key to select **YES**.
4. Press the red  key to return to the **READY** screen.

**Note:** To change the default values for tip entry, or to enable enhanced tip prompting for gift cards, refer to the **iCT250 Operating Manual** in WebHelp format at [moneris.com/support](https://moneris.com/support).





# Using Your Terminal

In this section, we go over everything you need to know to use your Moneris iCT250, including how to perform transactions and end-of-day processes.

## Moneris iCT250

Use this handheld, all-in-one terminal and PINpad to process transactions at the point of sale (POS).

When prompted, you (and sometimes your customer) will key in information on the terminal. If your customer is required to key in information, pass the handheld to the customer. When the customer has finished keying in the information, retrieve the terminal and complete the transaction.



## Terminal keys and hardware

- 1 **Function keys** 
  - Move through the menu items on the display.
  - Select the option displayed above the key: e.g. if YES displays above the  key, press that key to select YES. If  displays above the  key, press that key to scroll up.
  - To select an item, scroll through the list until the item is highlighted (e.g. LOGON vs. **LOGON**), and then press the green  key.
- 2 **Alpha-numeric keys**
  - Key in numbers, letters and punctuation (with the **Admin** key).
- 3 **Admin key** 
  - Go to the MAIN MENU from the READY screen.
  - Select letters and punctuation (with alphanumeric keys).
- 4 **Red Cancel key** 
  - Cancel a transaction.
  - Move back one menu at a time.
- 5 **Yellow Correct key/Paper feed key**
  - Clear displayed data one character at a time.
  - Press key (hold down) to advance the receipt paper in the printer
- 6 **Green OK key** 
  - Accept displayed data.
  - Submit data.
  - Select highlighted menu item.
- 7 **Printer**
  - To advance receipt paper, see label **5** above
- 8 **Keypad**
- 9 **Magnetic stripe reader**
- 10 **Chip reader**
- 11 **Display screen/Contactless reader (internal)**

**Note:** If the terminal's back light dims (keys lose their bright glow), press any key. The keys function even if the back light is dimmed.

## Optional external PINpad

If an optional Moneris iPP320 external PINpad is connected to the iCT250 terminal and your merchant account is configured for it, the customer uses the PINpad to input transaction information when prompted.

### General guidelines for the iPP320 PINpad

- When the CONTINUE ON PINPAD prompt appears on the iCT250 terminal, pass the iPP320 PINpad to your customer.
- The customer follows the prompts on the PINpad.
- For contactless transactions, the TAP CARD prompt always appears on the PINpad.
- Keep the terminal in front of you to complete the transaction.
- The PINpad displays WELCOME/BONJOUR while in its idle state.



- 1 Display screen/Contactless reader (internal)
- 2 Magnetic stripe reader
- 3 Chip reader

## Card types

The Moneris iCT250 supports the following card types and formats. These card types are not mutually exclusive. A single card can include a magnetic stripe, a chip, and contactless functionality.

### Magnetic stripe card

- A card with a magnetic stripe
- The card is swiped on the magnetic stripe reader

### Chip card

- A card with a chip
- The card is inserted into the chip card reader

### Contactless card

- In this guide, the term “contactless card” includes:
  - a card with contactless functionality; supported card brands include: Visa<sup>®</sup>, Mastercard<sup>®</sup>, American Express<sup>®</sup>, Discover<sup>®</sup>, and *Interac*<sup>®</sup>
  - a mobile device, such as a smartphone, tablet or smartwatch
  - other contactless-enabled items such a key fob or a mobile tag
- The card is tapped on the contactless reader.
- All contactless card formats and any related software are the responsibility of the cardholder (e.g., downloading a digital app from their financial institution).
- Cardholders with a mobile device (e.g., smartphone) are responsible for loading their card information into their digital wallet.

# Cardholder verification

## Cardholder verification methods (CVM)

Many transactions require cardholder verification. This means your customer must provide proof that they are the valid cardholder by performing one of the cardholder verification methods below. The terminal will prompt your customer (or you) for the appropriate CVM.

When verification is required, follow these general guidelines:

- for a transaction where a card is swiped, the cardholder signs the merchant copy of the receipt.
- for a transaction where a card is inserted, the cardholder enters their PIN on the terminal (or on the external PINpad if applicable). In some cases, the cardholder may need to sign the merchant copy of the receipt.
- for a transaction where a card is tapped, the cardholder signs the merchant copy of the receipt.
- for a transaction where a mobile device is tapped, the cardholder enters their passcode on their mobile device. If the cardholder has already entered their passcode, they will not be prompted again during the transaction.

## Cardholder verification limit

- This is the maximum dollar amount for performing a **tapped credit** transaction without cardholder verification.
- To determine the cardholder verification limit for a card, print a Configuration Report (see instructions on page 51). Look near the end of the report for the CVM LIMITS section, then look under each card type for the DOMESTIC CVM LIMIT.
- If the final transaction amount is greater than the limit specified (in the case of Visa, equal to or greater than) then the cardholder must perform one of the cardholder verification methods outlined on page 28.
- In most cases, this limit does not apply to:
  - Credit transactions where the card is swiped or inserted
  - *Interac* Debit transactions where the card is swiped or inserted

These transactions require cardholder verification regardless of the transaction amount.

# Card entry options

## Insert: Chip cards

1. SWIPE OR INSERT CARD or SWIPE/INSERT/TAPCARD displays on the terminal or external PINpad if attached.
2. Either you or the customer inserts the card into the device's chip reader.  
**Note:** *Unless the device prompts otherwise, do not swipe a chip card even if the card has a magnetic stripe.*
3. The customer may be prompted to key in a PIN.
4. The chip card must **remain inserted** until the REMOVE CARD prompt displays.



## Wave/Tap: Contactless cards

1. SWIPE/INSERT/TAP CARD displays on the terminal or external PINpad if attached.
2. The customer taps their card over the icon that appears on the display screen.  
**Note:** *The customer does not need to enter a PIN on the terminal or external PINpad. However, if the customer is using a mobile device, they may be directed to enter a passcode on their smartphone or tablet.*
3. Note the following:
  - Your merchant account must be configured for contactless functionality.
  - Only Purchases, Refunds, and Balance Inquiries can be processed using a contactless card.
  - The transaction amount must be equal to or less than the maximum Contactless Transaction Limit set for the card (see below).
  - The card must be within 0.5 in. (1.3 cm) of the screen, but it does not have to touch it.
  - The card must be tapped or waved by itself (the customer cannot leave the card in their wallet and wave it in front of the screen).



## Contactless Transaction Limit (CTL)

For each card type, there is a limit on the dollar value that can be processed as a contactless transaction.

- **Credit Cards (and some Debit cards):** To determine the CTL for a card, print a Configuration Report (see instructions on page 51). Look near the end of the report for the CVM LIMITS section, then look under each card type for the DOMESTIC TXN LIMIT. If this limit shows a value of 9999, then there is no contactless limit.

**Note:** *If a contactless credit card is tapped for an amount that exceeds its maximum CTL, the terminal or PINpad will display CONTACTLESS TRANSACTION LIMIT EXCEEDED (see message on page 56).*

- **Mobile Devices:** For Mastercard, look for the MC-M TXN LIMIT. If this limit shows a value of 9999, then there is no contactless limit for Mastercard on mobile devices. For all other cards, use the DOMESTIC TXN LIMIT as specified above.

- **Interac Flash Cards:** The maximum CTL is determined by the card and does not appear on any report.

**Note:** *If an Interac Flash card is tapped for an amount that exceeds its maximum CTL, the terminal or PINpad will display TAP FAILED PLEASE INSERT OR SWIPE CARD (see message on page 57).*

## Swipe: Magnetic stripe cards





1. SWIPE CARD or SWIPE OR INSERT CARD or SWIPE/INSERT/TAP CARD displays on the terminal or external PINpad if attached.
2. Swipe the card on the device's magnetic stripe reader.

**Note:** *If the card has a chip and the terminal or external PINpad if attached is enabled to read chip cards, the card must be inserted into the chip reader.*



## Manual card entry

If all available card entry methods fail, you may manually enter the card number for credit cards and some chip debit cards.

1. SWIPE CARD or SWIPE OR INSERT CARD or SWIPE/INSERT/TAP CARD displays on the terminal or external PINpad if attached.
2. Key in the card number on the terminal, and press the green  key.
3. Key in the card's expiry date (MMYY) on the terminal, and press the green  key.
  - If ENTER ADMIN PASSWORD appears, key in your admin password and press the green  key.
  - If SWIPE ADMIN CARD appears, swipe your POS Admin card on the terminal.
  - If TAKE MANUAL IMPRINT OF CARD AND PRESS OK appears, take a manual imprint of the card, and press the green  key.



# Transactions

All instructions in this section begin at the READY screen. To access the READY screen from any other screen, press the red  key repeatedly until the READY screen appears.

## General guidelines

1. If the terminal is configured to use Ethernet, ensure that the Ethernet icon  (at the top of the terminal display screen) is coloured green.
2. Determine the transaction to be processed (e.g., Purchase or Refund).
3. Establish the means of payment (credit or debit).
4. Enter the card data on the terminal or external PINpad if attached (see pages 29 - 30).
5. Follow the prompts\* (see pages 32 -44).
6. Process receipts (see pages 46-48).



*\*Prompts may vary depending on variables such as terminal setup, merchant setup and card type.*

**Note:** *Some debit cards may display Cashback and/or Account Selection and PIN prompts after the device has been returned to you; hand the device back to the customer to respond to these prompts.*

## Admin code shortcuts



To bypass scrolling through menus to select a transaction, use the Admin codes to jump directly to a transaction. Admin codes can be found in this section in square brackets beside the transaction name (e.g. **Logon [02]** means the Admin code for logging on is **02**).

### To use an Admin code:

1. Press the  key until ENTER ADMIN CODE appears.
2. Key in the Admin code, and press the green  key.

The transaction appears.



### To print a list of all Admin codes:

1. Press the  key until ENTER ADMIN CODE appears.
2. Key in **40**, and press the green  key.

The list is printed.

## Purchase [100]

Credit or debit purchase of goods or services.

1. If PURCHASE is the default, key in a Purchase amount. (If PURCHASE is not the default: Press the  key, select **TRANSACTIONS**, select **PURCHASE**, and then key in a Purchase amount.)
2. Press the green  key.
3. Follow the merchant prompts:
  - If tip entry is disabled, follow the merchant prompts table on page 34.
  - If tip entry is enabled, follow the merchant prompts table on page 41.

## Partially approved Purchase



A Partial Approval of a purchase transaction occurs when a cardholder pays for a purchase with a pre-paid credit card but the value on the pre-paid card is less than the purchase amount.

The amount on the pre-paid card is approved, i.e. part of the total purchase amount is approved. Prompts are displayed indicating how much of the purchase amount is still owed (e.g. AMOUNT DUE \$5.00). That amount can then be paid by another tender type, e.g. a credit or debit card.

## Refund [101] / VOID–Purchase [106] / VOID–Refund [107]

A Refund credits a customer's account. A Void cancels the original Purchase or Refund.



**Note:** Credit card Voids must be processed in the same batch as the original transaction.

1. Press the  key, select **TRANSACTIONS**, and then select the transaction (**REFUND** or **VOID-PURCHASE** or **VOID-REFUND**).
  - If SWIPE ADMIN CARD appears, swipe your POS Admin card.
2. Key in the transaction amount, and press the green  key.
3. Follow the merchant prompts table on page 34.

**Note:** To refund or void a partially approved purchase, use the **TOTAL PAID** amount on the Partial Approval receipt. See page 48.



## Pre-Authorization [102]

Authorization if the final Purchase amount is unknown (e.g. hotel or car rental).

1. If PRE-AUTH is the default, key in a Pre-Auth amount. (If PRE-AUTH is not the default: Press the  key, select **TRANSACTIONS**, select **PRE-AUTH**, and then key in a Pre-Auth amount.)
2. Press the green  key.
3. Follow the merchant prompts table on page 34.

**Note:** When the final Purchase amount is known, you must perform an Advice for the final amount using the same card number (see Advice options starting on page 33).

## Cheque Authorization [105]



1. Press the  key, select **TRANSACTIONS**, and select **CHEQUE AUTH**.
2. Do one of the following:
  - To do the authorization by credit card, select **CREDIT CARD**.
  - To do the authorization by driver's licence, select **DRIVERS LICNCE**.
3. Key in the cheque amount, and press the green  key.
4. Follow the merchant prompts table on page 36.
5. On the cheque, record the 8-digit APPROVED number then press the green  key.

**Note:** Receipts are not printed. ID types and province/state codes are provided by the authorization service.

## Advice using Sequence Number [103] / Force Post [103]

An Advice transaction completes or cancels a Pre-Auth. A Force Post transaction completes a voice-authorized purchase.







**Note:** The Advice transaction must be processed on the same terminal as the original Pre-Auth.

1. Press the  key, select **TRANSACTIONS**, and then select **P-A ADVICE**.
2. Follow the merchant prompts table on page 36.
3. After processing an Advice, the terminal returns to the FIND ORIGINAL TRANSACTION? prompt.
  - To go back to the READY screen, press the red  key twice.
  - To process another Advice, return to step 2.

## Advice List [109]

Completes or cancels a Pre-Auth from a list.

**Note:** The Advice List (P-A ADVICE LST) will appear only if Tip Reporting is enabled. The Advice must be processed on the same terminal as the original Pre-Auth.

1. Press the  key, select **TRANSACTIONS**, and then select **P-A ADVICE LST**.
  - If SWIPE ADMIN CARD appears, swipe your POS Admin card.
  - If ENTER CLERK ID appears: To narrow the search by Clerk ID, key in a clerk ID, and press the green  key. Otherwise, press the green  key for retrieval regardless of Clerk ID.
2. When ENTER AMOUNT or DATE or BATCH NUMBER appears: To narrow the scope of your search, key in the required data, and then press the green  key. Otherwise, for retrieval regardless of the specified prompt, simply press the green  key without entering the required data.
3. Scroll to the Pre-Auth that you want to complete or cancel (e.g., "PA1234 \$#.###"), and press the green  key.
4. Press the  key (COMPL), and follow the merchant prompts table on page 36.

5. After processing an Advice:

- To go back to the READY screen, press the red  key twice.
- To process another Advice:
  - From the ENTER AMOUNT screen, return to step 2, or
  - From the list of Pre-Auth transactions, return to step 3.

## Balance Inquiry [110]

Prints a cardholder receipt indicating the dollar value available on a pre-paid credit card.







1. Press the  key, select **TRANSACTIONS**, and then select **BAL INQUIRY**.
2. Follow the prompts but note:
  - The terminal only prints one copy of the balance inquiry receipt: the cardholder copy.
  - The balance is not displayed on the screen, only an APPROVED message.













## Prompts without tip entry

### Merchant prompts: Purchases/Pre-Auths/Refunds/Voids

This table lists in order of appearance the prompts (and the actions to take for each) that you might see on the terminal during a Purchase with tip entry disabled, Pre-Auth, Refund, or Void. For a *Purchase with tip entry enabled*, refer to page 41.





**Note:** Only some of the prompts listed below will appear for any one transaction.

Merchant prompt	Merchant action(s)
<b>ENTER CLERK ID</b>	Key in your Clerk ID, and press the green  key.
<b>ENTER INVOICE NO</b>	Key in an alphanumeric identifier, and press the green  key, or simply press the green  key to bypass.
<b>ENTER ORIGINAL AUTHORIZATION #</b>	Key in the 6-digit AUTH# from the original transaction receipt (see page 47), and press the green  key.
<b>SWIPE CARD</b> or <b>SWIPE OR INSERT CARD</b> or <b>SWIPE/INSERT/TAP CARD</b>	Enter the card on the terminal or the external PINpad if attached (see pages 29-30 for options).
<b>ENTER LAST 4 DIGITS</b>	Key in the last four digits of the card number, and press the green  key.
<b>ENTER EXPIRY DATE [MMYY]</b>	Key in the card's expiry date (MMYY), and press the green  key.
<b>SWIPE ADMIN CARD</b>	Swipe your POS Admin card.

Merchant prompt	Merchant action(s)
<b>REGULAR MAIL/TEL</b>	If cardholder is present: Press the green  key to select <b>REGULAR</b> . If cardholder is not present: Scroll to <b>MAIL/TEL</b> , and press the green  key.
<b>SINGLE RECURRING INSTALLMENT OTHER</b>	Scroll to the option that best describes the transaction, and press the green  key.
<b>TAKE MANUAL IMPRINT OF CARD AND PRESS OK</b>	Take a manual imprint of the card, and press the green  key.
<b>SELECT &lt;Application name&gt; YES NO</b>	To select the displayed application: Press the  key (YES). To view the next available application on the card: Press the  key (NO).
<b>&lt;Application name&gt; -OK? YES NO</b>	To use the displayed application, press the  key (YES).
<b>ENTER ORIGINAL AUTHORIZATION #</b>	Key in the 6-digit AUTH# found on the original transaction receipt (see page 47), and press the green  key.
<b>CUSTOMER PRESS OK TO CONTINUE</b>	Pass the terminal to the cardholder (see <i>Customer prompts on terminal</i> on page 38. If tip entry is enabled, see page 42).
<b>CONTINUE ON PINPAD</b>	Pass the PINpad to the cardholder (see <i>Customer prompts on PINpad</i> on page 40. If tip entry is enabled, see page 44).
<b>RETURN TO CLERK</b>	Press the green  key on the terminal to continue.
<b>APPROVED #####</b>	Press the green  key, and process any receipt that prints (see page 46).
<b>PARTIAL APPROVED \$000.00 PRESS OK</b>	Press the green  key on the terminal to continue.
<b>AMOUNT DUE \$00.00 CR/DB CASH</b>	If cardholder would like to pay a balance due by credit or debit, press the  key. If they would like to pay by cash, press the  key.
<b>UPDATE POINTS TO LOYALTY CARD? YES NO</b>	Refer to the <i>Moneris iCT250 Loyalty Programs Reference Guide</i> .

## Merchant prompts: Cheque Authorizations





This table lists in order of appearance the prompts on the terminal (and the actions to take for each) for this transaction.



















Merchant prompt	Merchant action
<b>ENTER DRIVERS LICENCE NUMBER</b>	Key in the cheque-holder's driver's licence number, and press the green  key.
<b>ENTER PROVINCE OR STATE CODE</b>	Key in the cheque-holder's 2-digit province/state code, and press the green  key.
<b>ENTER BIRTH DATE (YYMMDD)</b>	Key in the cheque-holder's birth date (YYMMDD), and press the green  key.
<b>SWIPE CARD</b>	Enter the card on the terminal or external PINpad if attached (see page 30 for options).
<b>ENTER LAST 4 DIGITS</b>	Key in the last four digits of the card number, and press the green  key.
<b>ENTER EXPIRY DATE [MMYY]</b>	Key in the card's expiry date (MMYY), and press the green  key.
<b>SWIPE ADMIN CARD</b>	Swipe your POS Admin card.
<b>APPROVED #####</b>	Go back to <i>Cheque Authorization</i> on page 33, and continue at step 5 of that procedure.











## Merchant prompts: Advices/Force Posts

This table lists in order of appearance the prompts (and the actions to take for each) that you might see on the terminal during an Advice or Force Post.

**Note:** Only some of the prompts listed below will appear for any one transaction.

Merchant prompt	Merchant action
<b>FIND ORIGINAL TRANSACTION?</b> YES                      NO	To do an Advice: Press the  key (YES). To do a Force Post: Press the  key (NO).
<b>ENTER ORIGINAL SEQUENCE NUMBER</b>	Key in the 6-digit portion of the RECEIPT NUMBER found on the Pre-Auth receipt (see <i>Pre-Auth Receipt</i> on page 47), and press the green  key.
<b>1234567890123456 PRESS [OK]</b>	Press the green  key to confirm the displayed card number.







Merchant prompt	Merchant action
<b>ENTER AMOUNT</b> \$#.##	<b>Advice:</b> To complete the Pre-Auth: Key in the amount written on the Total line (sum of the printed Pre-Auth amount plus written Tip amount if any (see <i>Pre-Auth Receipt</i> on page 47), and press the green  key. To cancel the Pre-Auth: Press the yellow  key (this enters \$0.00), and press the green  key. <b>IVR Auth:</b> Key in the authorized transaction amount, and press the green  key.
<b>ENTER ORIGINAL AMOUNT</b> \$#.##	<b>Advice:</b> To complete the Pre-Auth: Key in the printed Pre-Auth amount found on the receipt (see <i>Pre-Auth Receipt</i> on page 47), and press the green  key. To cancel the Pre-Auth: Press the yellow  key (this enters \$0.00), and press the green  key. <b>IVR Auth:</b> Key in the authorized transaction amount, and press the green  key.
<b>ENTER TIP AMOUNT</b> \$0.00	<b>Advice:</b> Key in the amount written on the Tip line (see <i>Pre-Auth Receipt</i> on page 47), and press the green  key. <b>IVR Auth:</b> Key in the authorized Tip amount, and press the green  key.
<b>FINAL AMOUNT</b> \$#.##-OK?	Press the green  key to continue.
<b>ENTER CLERK ID</b>	Key in your Clerk ID, and press the green  key; or To accept the displayed ID, simply press the green  key.
<b>ENTER INVOICE NO</b>	Key in an alpha/numeric identifier, and press the green  key; or To bypass this prompt, simply press the green  key.
<b>ENTER ORIGINAL AUTHORIZATION #</b>	Key in the (IVR) Auth # written on your paper sales draft, and press the green  key.
<b>ENTER CARD NUMBER</b>	Key in the card number, and press the green  key.
<b>ENTER EXPIRY DATE [MMYY]</b>	Key in the card's expiry date (MMYY), and press the green  key.
<b>SWIPE ADMIN CARD</b>	Swipe your POS Admin card.

Merchant prompt	Merchant action
<b>REGULAR MAIL/TEL</b>	If cardholder is present: Press the green  key to select <b>REGULAR</b> . If cardholder is not present, scroll to <b>MAIL/TEL</b> , and press the green  key.
<b>SINGLE RECURRING INSTALLMENT OTHER</b>	Scroll to the option that best describes the transaction, and press the green  key.
<b>ENTER INVOICE NO</b>	Key in an alpha/numeric identifier, and press the green  key; or To bypass this prompt, simply press the green  key.
<b>APPROVED #####</b>	Press the green  key, and process any receipts that print (see page 46).
<b>FIND ORIGINAL TRANSACTION? YES                    NO</b>	To process next Advice: Press the  key (YES). To return to READY screen: Press the  key (NO), then press the red  key.
<b>TRANSACTION NOT FOUND</b>	Press the green  key to return to the READY screen. (There are no other Pre-Auths stored in the terminal's memory.)
<b>USE LOYALTY INFO FROM PRE-AUTH? YES                    NO</b>	Refer to the <i>Moneris iCT250 Loyalty Programs Reference Guide</i> .

















### Customer prompts: On the terminal

This table lists in order of appearance the prompts (and the actions to take for each) that your customer might see on the terminal during a transaction when tip entry is disabled. For a *Purchase with tip entry enabled*, refer to page 42.

**Note:** Only some of the prompts listed below will appear for any one transaction.

Customer prompt	Customer action
<b>CUSTOMER PRESS OK TO CONTINUE</b>	Presses the green  key.
<b>SELECT LANGUAGE ENGLISH FRANCAIS</b>	For English prompts: Presses the  key (ENGLISH). For French prompts: Presses the  key (FRANCAIS).
<b>SELECT &lt;Application name&gt; YES                    NO</b>	To select the displayed application: Presses the  key (YES). To view the next available application: Presses the  key (NO).
<b>&lt;Application name&gt; -OK?</b>	Presses the  key (YES) to use the displayed application.























Customer prompt	Customer action
<b>CASH BACK?</b> YES                      NO	To receive cash back: Presses the  key (YES). For no cash back: Presses the  key (NO).
<b>SELECT CASH BACK</b> \$AA        \$BB    \$CC	Presses the  or  or  key to select a displayed amount.
<b>SELECT CASH BACK</b> \$AA    \$BB    OTHER	To select a displayed amount: Presses the  key (\$AA) or the  key (\$BB). To select another amount: Presses the  key (OTHER), keys in amount, then presses the green  key.
<b>PURCHASE</b> \$#.##-OK?	Presses the green  key to confirm the displayed amount.
<b>SELECT ACCOUNT</b> CHEQUING SAVINGS	For chequing: Presses the  key (CHEQUING). For savings: Presses the  key (SAVINGS).
<b>ENTER PIN &amp; OK</b>	Keys in their Personal Identification Number and presses the green  key.
<b>RETURN TO CLERK</b>	Returns the terminal to you (see RETURN TO CLERK prompt on page 35).
<b>APPROVED</b> #####	Returns the terminal to you (see APPROVED ##### prompt on page 35).
<b>PARTIAL APPROVED</b> \$000.00 CANCEL                      OK	To confirm the transaction: Presses the  key. To cancel the partial approval on their pre-paid card: Presses the  key.
<b>AMOUNT DUE</b> \$000.00 PRESS OK	Presses the green  key to confirm the amount due on a partial approval purchase.
<b>CARD BALANCE</b> \$000.00 PRESS OK	Presses the green  key to acknowledge the card balance. <i>Note: The remaining balance is displayed during a Partial Approval transaction if the pre-paid card allows this.</i>
<b>REMOVE CARD</b>	Removes their card from chip reader and returns the terminal to you (see APPROVED ##### prompt on page 35).

## Customer prompts: On the PINpad

This table lists in order of appearance the prompts (and the actions to take for each) that your customer might see on the external PINpad during a transaction with tip entry disabled. For a *Purchase with tip entry enabled*, refer to page 44.

**Note:** Only some of the prompts listed below will appear for any one transaction.

Customer prompt	Customer action
<b>SELECT LANGUAGE</b> ENGLISH FRANCAIS	For English prompts: Presses the  key (ENGLISH). For French prompts: Presses the  key (FRANCAIS).
<b>SELECT</b> <Application name> YES NO	To select the displayed application: Presses the  key (YES). To view the next available application: Presses the  (NO).
<Application name> -OK?	Presses the  key (YES) to use the displayed application.
<b>CASH BACK?</b> YES NO	To receive cash back: Presses the  key (YES). For no cash back: presses the  key (NO).
<b>SELECT CASH BACK</b> \$AA \$BB \$CC	Presses the  or  or  key to select a displayed amount.
<b>SELECT CASH BACK</b> \$AA \$BB OTHER	To select a displayed amount: Presses the  key (\$AA) or the  key (\$BB). To select another amount: Presses the  key (OTHER), keys in amount, then presses the green  key.
<b>PURCHASE</b> \$#.##-OK?	Presses the green  key to confirm the displayed amount.
<b>SELECT ACCOUNT</b> CHQ SAV	For chequing: Presses the  key (CHQ). For savings: Presses the  key (SAV).
<b>ENTER PIN &amp; OK</b>	Keys in their PIN (Personal Identification Number) and presses the green  key.
<b>PARTIAL APPROVED</b> \$000.00 CANCEL OK	Presses the  key to CANCEL the partial approval on their pre-paid card. Presses the  key to confirm the transaction.
<b>AMOUNT DUE</b> \$000.00 PLEASE WAIT	Tells merchant which payment method they wish to use for a balance due, debit/credit or cash.
<b>APPROVED</b> THANK YOU	Returns the PINpad to you (see APPROVED ##### prompt on page 35).
<b>REMOVE CARD</b>	Removes their card from chip reader and returns the PINpad to you (see APPROVED ##### prompt on page 35).













## Prompts with tip entry



When tip entry is enabled on the terminal, the order of prompts is revised to display customer prompts, including tip entry, in a more efficient way for the customer. Follow the tables below when performing a purchase transaction with tipping enabled.

### Merchant prompts: Purchase with tip enabled

This table lists in order of appearance the prompts (and the actions to take for each) that you might see on the terminal during a Purchase with tip entry enabled.

**Note:** Only some of the prompts listed below will appear for any one transaction.













Merchant prompt	Merchant action
<b>ENTER CLERK ID</b>	Key in your Clerk ID, and press the green  key.
<b>ENTER INVOICE NO</b>	Key in an alpha/numeric identifier, and press the green  key; or To bypass this prompt, simply press the green  key.
<b>CUSTOMER PRESS OK TO CONTINUE</b>	Pass the terminal to the cardholder (see <i>Customer prompts on terminal on page 42</i> ).
<b>CONTINUE ON PINPAD</b>	Pass the PINpad to the cardholder (see <i>Customer prompts on PINpad on page 44</i> ). To change the language on the PINpad to French, press the  key.
<b>ENTER LAST 4 DIGITS</b>	Key in the last four digits of the card number, and press the green  key.
<b>ENTER EXPIRY DATE [MMYY]</b>	Key in the card's expiry date (MMYY), and press the green  key.
<b>REGULAR MAIL/TEL</b>	If cardholder is present: Press the green  key to select REGULAR. If cardholder is not present: Scroll to MAIL/TEL, and press the green  key.
<b>SINGLE RECURRING INSTALLMENT OTHER</b>	Scroll to the option that best describes the transaction, and press the green  key.
<b>TAKE MANUAL IMPRINT OF CARD AND PRESS OK</b>	Take a manual imprint of the card, and press the green  key.
<b>RETURN TO CLERK</b>	Press the green  key on the terminal to continue.
<b>APPROVED #####</b>	Press the green  key, and process any receipt that prints (see page 46).























Merchant prompt	Merchant action
PARTIAL APPROVED \$000.00 PRESS OK	Press the green  key on the terminal to continue.
AMOUNT DUE \$00.00 CR/DB            CASH	If cardholder would like to pay the balance due: <ul style="list-style-type: none"> <li>by credit or debit, press the  key.</li> <li>by cash, press the  key.</li> </ul>
UPDATE POINTS TO LOYALTY CARD? YES                NO	Refer to the <i>Moneris iCT250 Loyalty Programs Reference Guide</i> .





### Customer prompts on the terminal: Purchase with tip entry enabled

This table lists in order of appearance the prompts (and the actions to take for each) that your customers might see on the terminal during a Purchase when tipping is enabled.

**Note:** Only some of the prompts listed below will appear for any one transaction.

Customer prompt	Customer action
CUSTOMER PRESS OK TO CONTINUE	Presses the green  key. OR To change the language to French, presses the  key (FRANCAIS).
PURCHASE \$#.##-OK?	Presses the green  key to confirm the displayed amount.
ADD TIP? YES                NO	To proceed with entering a tip, presses the  key (YES). To bypass tipping, presses the  key (NO).
ENTER TIP OR PRESS OK AA%                OTHER	To enter preset %: Presses the  key (AA%). To enter different Tip amount: Presses the  key (OTHER). To bypass entering Tip: Presses the green  key.
ENTER TIP OR PRESS OK PERCENT    AMOUNT %                \$	To enter Tip: Presses the  key (%) or the  key (\$). To bypass entering Tip: Presses the green  key.
ENTER TIP PERCENTAGE AA%	Keys in a percentage (or nothing at all), then presses the green  key.
ENTER TIP AMOUNT \$0.00	Keys in a dollar amount (or nothing at all), then presses the green  key.













Customer prompt	Customer action
<b>SELECT TIP</b> <b>1 - AA%=\$0.00</b> 2 - AA% = \$0.00 3 - AA% = \$0.00 4 - OTHER	To select the highlighted preset %: Presses the green  key. To select a different pre-set %: Scrolls to the desired % and presses the green  key. To enter a different amount: Scrolls to OTHER and presses the green  key.
<b>PURCHASE</b> <b>\$#.##-OK?</b>	Presses the green  key to confirm the displayed amount.
<b>SWIPE OR INSERT CARD /</b> <b>GLISSER OU INSERER CARTE</b>	Swipes or inserts the card.
<b>SWIPE/INSERT/TAP CARD</b> <b>GLISSER, INSERER, OU</b> <b>PRESENTER CARTE</b>	Swipes, inserts, or taps the card. Customer may also tap their mobile device (e.g. smartphone) or other mobile format.
<b>SELECT LANGUAGE</b> <b>CHOISIR LANGUE</b> <b>ENGLISH FRANCAIS</b>	For English prompts: Presses the  key (ENGLISH). For French prompts: Presses the  key (FRANCAIS).
<b>SELECT</b> <b>&lt;Application name&gt;</b> <b>YES NO</b>	To select the displayed application: Presses the  key (YES). To view the next available application: Presses the  key (NO).
<b>&lt;Application name&gt;</b> <b>-OK?</b>	Presses the  key (YES) to use the displayed application.
<b>CASH BACK?</b> <b>YES NO</b>	To receive cash back: Presses the  key (YES). For no cash back: Presses the  key (NO).
<b>SELECT CASH BACK</b> <b>\$AA \$BB \$CC</b>	Presses the  or  or  key to select a displayed amount.
<b>SELECT CASH BACK</b> <b>\$AA \$BB OTHER</b>	To select a displayed amount: Presses the  key (\$AA) or the  key (\$BB). To select another amount: Presses the  key (OTHER), keys in amount, then presses the green  key.
<b>PURCHASE</b> <b>\$#.##-OK?</b>	Presses the green  key to confirm the displayed amount.
<b>SELECT ACCOUNT</b> <b>CHEQUING SAVINGS</b>	For chequing: Presses the  key (CHEQUING). For savings: Presses the  key (SAVINGS).
<b>ENTER PIN &amp; OK</b>	Keys in their Personal Identification Number and presses the green  key.
<b>RETURN TO CLERK</b>	Returns the terminal to you (see RETURN TO CLERK prompt on page 41).
<b>APPROVED</b> <b>#####</b>	Returns the terminal to you (see APPROVED ##### prompt on page 41).





















Customer prompt	Customer action
<b>PARTIAL APPROVED</b> \$000.00 CANCEL OK	To confirm the transaction: Presses the  key. To cancel the partial approval on their pre-paid card: Presses the  key.
<b>AMOUNT DUE</b> \$000.00 PRESS OK	Presses the green  key to confirm the amount due on a partial approval purchase.
<b>CARD BALANCE</b> \$000.00 PRESS OK	Presses the green  key to acknowledge the card balance. <b>Note:</b> <i>The remaining balance is displayed during a Partial Approval transaction if the pre-paid card allows this.</i>
<b>REMOVE CARD</b>	Removes their card from chip reader and returns the terminal to you (see APPROVED ##### prompt on page 41 ).

### Customer prompts on the PINpad: Purchase with tip enabled

This table lists in order of appearance the prompts (and the actions to take for each) that your customers might see on the external PINpad during a transaction when tip entry is enabled.

**Note:** *Only some of the prompts listed below will appear for any one transaction.*

Customer prompt	Customer action
<b>PURCHASE</b> \$#.##-OK?	Presses the green  key to confirm the displayed amount.
<b>ADD TIP?</b> YES NO	To proceed with entering a tip, presses the  key (YES). To bypass tipping, presses the  key (NO).
<b>TIP AMOUNT</b> AA% OTHER	To enter preset %: Presses the  key (AA%). To enter different Tip amount: Presses the  key (OTHER). To bypass entering Tip: Presses the green  key.
<b>TIP AMOUNT</b> % \$	To enter Tip: Presses the  key (%) or the  key (\$). To bypass entering Tip: Presses the green  key.
<b>TIP PERCENTAGE</b>	Keys in a percentage (or nothing at all), then presses the green  key.
<b>TIP AMOUNT</b> \$0.00	Keys in a dollar amount (or nothing at all), then presses the green  key.
<b>SELECT TIP</b> F1 - AA%=\$0.00 F2 - AA% = \$0.00 F3 - AA% = \$0.00 F4 - OTHER	To select one of the displayed tip percentages, presses the corresponding function key. To enter a different tip, presses the  key (OTHER).
<b>PURCHASE</b> \$#.##-OK?	Presses the green  key to confirm the displayed amount.

Customer prompt	Customer action
<b>SWIPE OR INSERT CARD / GLISSER OU INSERER CARTE</b>	Swipes or inserts the card on the PINpad.
<b>SWIPE/INSERT/TAP CARD GLISSER, INSERER OU PRESENTER CARTE</b>	Swipes, inserts, or taps the card on the PINpad. Customer may also tap their mobile device (e.g. smartphone) or other mobile format.
<b>SELECT LANGUAGE CHOISIR LANGUE ENGLISH FRANCAIS</b>	For English prompts: Presses the  key (ENGLISH). For French prompts: Presses the  key (FRANCAIS).
<b>SELECT &lt;Application name&gt; YES NO</b>	To select the displayed application: Presses the  key (YES). To view the next available application: Presses the  (NO).
<b>&lt;Application name&gt; -OK?</b>	Presses the  key (YES) to use the displayed application.
<b>CASH BACK? YES NO</b>	To receive cash back: Presses the  key (YES). For no cash back: Presses the  key (NO).
<b>SELECT CASH BACK \$AA \$BB \$CC</b>	Presses the  or  or  key to select a displayed amount.
<b>SELECT CASH BACK \$AA \$BB OTHER</b>	To select a displayed amount: Presses the  key (\$AA) or the  key (\$BB). To select another amount: Presses the  key (OTHER), keys in amount, then presses the green  key.
<b>PURCHASE \$#.##-OK?</b>	Presses the green  key to confirm the displayed amount.
<b>SELECT ACCOUNT CHQ SAV</b>	For chequing: Presses the  key (CHQ). For savings: Presses the  key (SAV).
<b>ENTER PIN &amp; OK</b>	Keys in their PIN (Personal Identification Number) and presses the green  key.
<b>PARTIAL APPROVED \$000.00 CANCEL OK</b>	To confirm the transaction: Presses the  key. To cancel the partial approval on their pre-paid card: Presses the  key.
<b>AMOUNT DUE \$000.00 PLEASE WAIT</b>	Tells merchant which payment method they wish to use for a balance due, debit/credit or cash.
<b>APPROVED THANK YOU</b>	Returns the PINpad to you (see APPROVED ##### prompt on page 41).
<b>REMOVE CARD</b>	Removes their card from chip reader and returns the PINpad to you (see APPROVED ##### prompt on page 41).

# Receipts

## Signing credit card receipts

### Merchant copy

Always retain this copy for your records, but note:

- If a signature line is printed, obtain the cardholder's signature.
- You do not need to obtain a signature if any of the following messages are printed:
  - VERIFIED BY PIN
  - NO SIGNATURE REQUIRED

### Cardholder copy

Give this copy to the customer, but note:

- If a merchant signature line is printed, sign this copy.

## Reprinting receipts

### Reprint customer receipt or last report [29]

Prints a duplicate of the last printout.

1. Press the  key, select ADMIN, and select REPRINT.  
The receipt or report prints.

### Reprint merchant receipt

See *Reprint merchant receipt* on page 49.

## Card masking

To reduce the risk of fraudulent card use, masking and truncation are applied to card numbers printed on receipts. Masking replaces a card's numbers with asterisks (e.g., \*\*\*\*\*1234).

Truncation prints only the last 4 digits of a card (e.g., 1234). The expiry date is not printed on any copy of any receipt.



## Contactless transactions

Receipts can be suppressed for tapped credit transactions that do not require cardholder verification. Refer to printer configuration in the **Moneris iCT250 Operating Manual** in WebHelp format located at [moneris.com/manuals](http://moneris.com/manuals).

Receipts are always printed for *Interac* Flash transactions.

## Receipt samples

These sample receipts will help you to locate the sequence number (for Advices) or the authorization number (for refunds and voids).

### Pre-Auth receipt sample

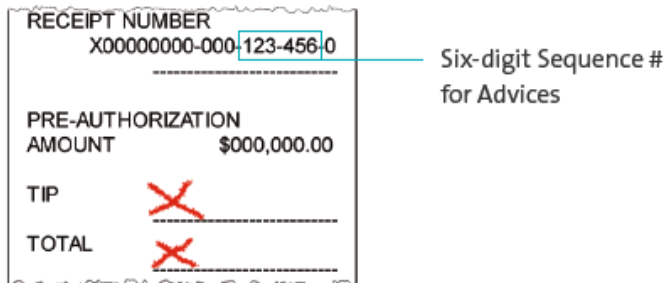

### Original receipt sample

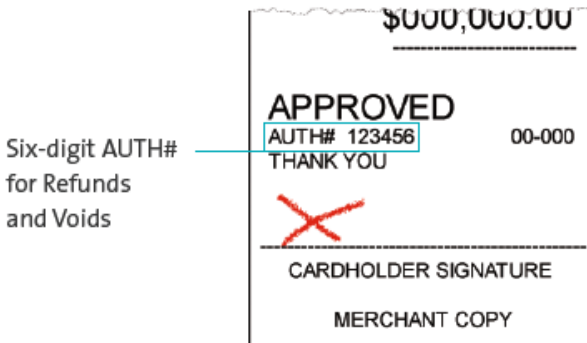

## Partial Approval receipt sample

PURCHASE TOTAL	\$100.00	
-----		
TOTAL PAID	\$25.00	Total paid with pre-paid credit card
-----		
AMOUNT DUE	\$75.00	Total amount still due in transaction (Purchase Total)
<b>PARTIAL APPR</b>		
AUTH#	123456	00-000
THANK YOU		
-----		
CARDHOLDER SIGNATURE		
MERCHANT COPY		
BALANCE:		





# Reports

## Masking on reports

To reduce the risk of fraudulent card use, masking and/or truncation is applied to card numbers printed on reports. The expiry date is not printed.

## Reprint merchant receipt [66]







Prints a duplicate of the Merchant Copy receipt.

1. Press the  key, select REPORTS, and select TRANS INQUIRY.
  - If SWIPE ADMIN CARD appears, swipe your POS Admin card.
  - If ENTER CLERK ID appears, key in your Clerk ID, and press the green  key.
2. Identify the transaction (follow the prompts).
  - When PRINT OR DISPLAY? appears, press the  key (DISPLAY), scroll to the transaction, and press the green  key. Then press the  key (REPRINT).

## Clerk subtotals report [82]

Prints transactions by Clerk ID for one, a group, or all clerks. Transactions are grouped by type and itemized under card type. Grand total amount(s) also appear for each Clerk ID.



**Note:** Clerk Subtotalling must be enabled.

1. Press the  key, select **REPORTS**, and select **CLERK INQUIRY**.
  - If SWIPE ADMIN CARD appears, swipe your POS Admin card.
2. Select the number of clerks to include:
  - For one clerk, press the  key (SINGLE). When ENTER CLERK ID appears, key in a Clerk ID, and press the green  key.
  - For a specific group of clerks, press the  key (MULTIPLE), then select GROUP. When ENTER GROUP ID TO BE PROCESSED appears, key in the Group ID and press the green  key, then select PROCESS LIST.
  - For all clerks, press the  key (MULTIPLE) then select ALL CLERKS.

The report prints, and the READY screen appears.



## Current batch totals report [99]

Prints a report listing transactions by card type for the current batch (terminal) without closing the batch. Grand totals by transaction type are also included in the report.

1. Press the  key, select **REPORTS**, then select **CLOSE BATCH**.
  - If SWIPE ADMIN CARD appears, swipe your POS Admin card.
  - If ENTER CLERK ID appears, key in your Clerk ID, and press the green  key. CLOSE BATCH appears, and then the report prints.
2. When CLOSE BATCH? appears, press the  key (NO) to finish printing without closing the batch.  
The report prints, and the READY screen appears.







## Merchant sub-totals report [95]

Prints a list of transaction type totals by card type for the current batch from the Moneris host. Grand totals by transaction type are also included.

1. Press the  key, select **REPORTS**, and select **MERCH SUBTOTAL**.
  - If SWIPE ADMIN CARD appears, swipe your POS Admin card.
  - If ENTER CLERK ID appears, key in your Clerk ID, and press the green  key.  
The report prints, and the READY screen appears.

## Pre-auth list [62]

Prints a list of Pre-Auths and identifies open Pre-Auths that need to be completed or cancelled.

1. Press the  key, select **REPORTS**, then select **PRE-AUTH LIST**.
2. When SWIPE ADMIN CARD appears, swipe your POS Admin card, or press the green  key to continue.
  - If ENTER CLERK ID appears, key in your Clerk ID, and press the green  key.
3. Select **OPEN** or **CLOSED** (for completed or cancelled Pre-Auths) or **BOTH** (for both types).  
PRINT DATE OR BATCH? appears.
4. To print the report by date, press the  key (DATE). To print the report by batch, press the  key (BATCH).
5. To print the current date or batch, press the green  key. To select a specific date or batch, key in a date or batch number, and press the green  key.  
The report prints, and the READY screen appears.



## Balance inquiry report [94]

Prints the number of balance inquiries by card type for the current batch. A grand total of inquiries is displayed at the bottom of the report.

1. Press the  key, select **REPORTS**, and select **BAL INQ REPORT**.
2. When SWIPE ADMIN CARD appears, swipe your POS Admin card.  
The report prints and the READY screen appears.

## Configuration report [16]









This report lists terminal parameters and values.

1. From the READY screen, press the  key twice, key in 16, and press the green  key.
2. When PRINT TRAILER MESSAGES? appears, press the  key (NO). The report prints.

## Tip totals report [96]

Prints a summary of Tip amounts entered on the terminal for transactions in a specified batch or a specified date range.

**Note:** If Clerk Subtotalling is enabled, Tip amounts are summarized by Clerk ID.

1. Press the  key, select **REPORTS**, then select **TIP TOTALS**.
  - If SWIPE ADMIN CARD appears, swipe your POS Admin card.
  - If ENTER CLERK ID appears:
    - to print the Tip total for a specific clerk, key in a Clerk ID;
    - to print Tip totals for all clerks, press the green  key.  
The PRINT DATE OR BATCH? prompt appears.
2. For totals by date, press the  key (DATE); for totals by batch, press the  key (BATCH).
  - If DATE is selected:
    - a. When START DATE appears, key in the start date (YYMMDD), and press the green  key.
    - b. When START TIME appears, key in the start time (HHMM, 24-hour clock), and press the green  key.
    - c. When END DATE appears, key in the end date (YYMMDD), and press the green  key.
    - d. When END TIME appears, key in the end time (HHMM, 24-hour clock), and press the green  key.
  - If BATCH is selected, key in the batch number, and press the green  key.

The report prints, and the READY screen appears.

# Admin functions

## Logon [02]

If PLEASE LOGON appears, you are required to log on.

1. Press the  key, select **ADMIN**, then select **LOGON**.
  - If SWIPE ADMIN CARD appears, swipe your POS Admin card.

The READY screen appears within 60 seconds.

## Logoff [03]





To ensure unauthorized transactions cannot be processed, log off your terminal at the end of each business day.

1. Press the  key, select **ADMIN**, then select **LOGOFF**.

The PLEASE LOGON prompt appears within 60 seconds.

## Re-initialization [01]

Moneris Customer Care may ask you to re-initialize your terminal if changes have been made to it or your merchant account.





1. Press the  key, select CONFIGURATION, then select INITIALIZATION.
  - If SWIPE ADMIN CARD appears, swipe your POS Admin card.
  - If RETAIN CURRENT MERCH SETTINGS? appears, press the key  (YES) to keep all parameters set as they are.
  - If MERCHANT ID appears, simply press the green  key.
  - If PHONE NUMBER appears, simply press the green  key.
2. Wait while the terminal communicates with the Moneris host.
  - If SWIPE ADMIN CARD appears, swipe your POS Admin card to log on.
3. When the READY screen appears on the terminal, it is ready to process transactions.

# End-of-day process



## Merchant close

If your merchant account is set up for Merchant Close settlement, you must process a Batch Close transaction in order to have the funds from your POS transactions deposited to your business account. Here's how:

### Step 1: Print a stored transactions report [60]

1. Press the  key, select **REPORTS**, and select **TRANS LIST**.
2. When SWIPE ADMIN CARD appears, swipe your POS Admin card, or press the green  key to continue.
  - If ENTER CLERK ID appears, key in a Clerk ID and press the green  key to print totals for that Clerk ID, or simply press the green  key to print totals for all Clerk IDs.



The PRINT DATE OR BATCH? prompt appears.

3. Press the  key (BATCH) to print the report by Batch.
4. Press the green  key to print the report for the current batch.

The PRINT TOTALS ONLY? prompt appears.
5. Press the  key (YES) to print only the Terminal Batch Totals (including the Cashback total).

The report prints, and the READY screen appears.

### Step 2: Process a close batch transaction [99]

1. Press the  key, select **REPORTS**, and select **CLOSE BATCH**.
  - If SWIPE ADMIN CARD appears, swipe your POS Admin card.
  - If ENTER CLERK ID appears, key in your Clerk ID, and press the green  key.

CLOSE BATCH appears, and then the report prints.

2. When CLOSE BATCH? appears, press the  key (YES) to close the batch and have funds deposited to your account.

The terminal finishes printing the report and returns to the READY screen.

### Step 3: Confirmation

Confirm that the totals on the Stored Transactions report (printed in step 1) match the totals on the Batch Totals report (printed in step 2). If they do not match, call Moneris Customer Care toll-free at **1-866-319-7450** the next business day for reconciliation assistance.

## System close

If your merchant account is set up for System Close settlement, Moneris automatically closes your batch for you at the end of each day. You must verify transaction totals on a daily basis. Here's how:

### **Step 1: Print a stored transactions report [60]**

See page 53.

### **Step 2: Print a merchant subtotals report [95]**

See page 50.



**Note:** *The Merchant Subtotals report must be printed before 11:00 p.m. local time.*

### **Step 3: Confirmation**



Confirm that the totals on the Stored Transactions report (printed in step 1) match the totals on the Merchant Subtotals report (printed in step 2). If they do not match, call Moneris Customer Care toll-free at [1-866-319-7450](tel:1-866-319-7450) within 30 days for reconciliation assistance.











## Troubleshooting



If an error message appears, first press the green  key or the red  key to clear the message then retry the transaction. If the error message reappears and is listed in the table below, follow the instructions in the table. If the problem is still not resolved, call Moneris Customer Care toll-free at [1-866-319-7450](tel:1-866-319-7450).

### Error messages



Message	Solution
<b>AMOUNT EXCEEDED</b>	The Refund amount was greater than the Refund Limit. Refer to REFUND LIMIT EXCEEDED on page 57.
<b>CARD BLOCKED REMOVE CARD</b>	The chip card cannot be used. Ask for another form of payment.
<b>CARD NOT SUPPORTED PLEASE RETRY</b>	Try swiping the card again. If this message reappears, request another form of payment.
<b>CARD PROBLEM</b>	Retry the transaction. If the message reappears: <ul style="list-style-type: none"> <li>▪ If credit card was swiped: Key in the card number.</li> <li>▪ If debit card was swiped: Request another form of payment.</li> <li>▪ If card was inserted: Swipe the card.</li> </ul>
<b>CARD REMOVED</b>	The chip card was removed during the transaction. <ol style="list-style-type: none"> <li>1. Retrieve the iCT250 or iPP320.</li> <li>2. Press the green  key until the READY screen appears.</li> <li>3. Retry the transaction.</li> </ol>
<b>CHECK PHONE THEN TAP AGAIN</b>	The customer's mobile device (e.g. smartphone) requires a response. The customer performs the following actions: <ol style="list-style-type: none"> <li>1. Checks their mobile device and responds to any prompts displayed there, e.g. they may need to enter a passcode on their mobile device.</li> <li>2. On the iCT250 or iPP320, presses the green  key or waits for the SWIPE/INSERT/TAP CARD prompt to re-appear.</li> <li>3. Taps the mobile device again.</li> </ol>
<b>CHECK PINPAD</b>	<ol style="list-style-type: none"> <li>1. Press the red  key on the iCT250 to cancel the transaction.</li> <li>2. Check the PINpad cable, and retry the transaction.</li> </ol>

Message	Solution
<b>CHECK PRINTER</b>	<ol style="list-style-type: none"> <li>1. Open the printer, and ensure that a paper roll is inside and that it is properly inserted.</li> <li>2. Close the printer lid.</li> <li>3. If required, press and hold down the yellow  key to advance the paper to the desired length.</li> </ol>
<b>CONTACTLESS TRANSACTION LIMIT EXCEEDED</b>	If the card has a chip, insert it into the chip reader; if the card does not have a chip, swipe the card.
<b>CUSTOMER — INSERT CARD INTO READER</b>	Insert the chip card into the chip card reader.
<b>DECLINED BY CARD</b>	<p>The chip card has declined the transaction.</p> <ol style="list-style-type: none"> <li>1. Retrieve the iCT250 or iPP320 if attached, and remove the chip card.</li> <li>2. Press the green  key on the iCT250 until the READY screen appears.</li> <li>3. Request another form of payment.</li> </ol>
<b>DECLINED – RETRY TRANSACTION?</b>	<ol style="list-style-type: none"> <li>1. Press the  key (YES).</li> <li>2. Retry the transaction.</li> </ol>
<b>DO A PURCHASE WITH CHIP CARD</b>	<p>The chip card cannot be used for a Pre-Auth transaction because the terminal is not configured to allow this.</p> <ol style="list-style-type: none"> <li>1. Retrieve the iCT250 or iPP320 if attached.</li> <li>2. Remove the chip card.</li> <li>3. Press the green  key on the iCT250.</li> <li>4. Perform a Purchase instead.</li> </ol>
<b>ERROR 40#</b>	<p>Communication error.</p> <ol style="list-style-type: none"> <li>1. Press the green  key to return to the READY screen.</li> <li>2. Retry the transaction.</li> </ol>
<b>ETHERNET COMMS ERROR-DIAL USED PRESS OK</b>	<p>Ethernet connection error – if available, dial backup was used for this transaction.</p> <p>Press the green  key to return to the READY screen.</p>
<b>INVALID CARD TYPE</b>	The card that was swiped cannot be used for this transaction. Ask for another card and retry.
<b>INVALID ENTRY</b>	In Training mode, ensure the transaction, Cashback, or Tip amount is \$1.00 or less (max. total: \$3.00).

Message	Solution
<b>NO LINE DETECTED</b>	Check that all cables are connected to the terminal's Magic Box and the wall jack correctly. If the message reappears, unplug and replug the power cable at the power source.
<b>NO SUPPORTED APPLICATIONS REMOVE CARD</b>	<ul style="list-style-type: none"> <li>▪ <b>If card was inserted:</b> Remove card from the reader, and swipe it on the iCT250 (do not swipe on the iPP320 if attached).</li> <li>▪ <b>If card was tapped:</b> If the card has a chip, insert it into the chip reader of the iCT250 or iPP320 if attached; if there is no chip, swipe on the iCT250 (do not swipe on iPP320 if attached).</li> </ul>
<b>NOT ACCEPTED REMOVE CARD</b>	<ol style="list-style-type: none"> <li>1. Remove the chip card from the chip reader.</li> <li>2. When prompted, swipe the card on the magnetic stripe reader, or (for credit) key in the card number. For debit, ask for another form of payment.</li> </ol>
<b>NOT COMPLETED RETURN TO CLERK</b>	<p><b>On the iCT250 terminal:</b></p> <ol style="list-style-type: none"> <li>1. Press the red  key to display the communications error.</li> <li>2. When the READY screen appears, check all the cable connections.</li> <li>3. Try the transaction again.</li> </ol> <p><b>On the iPP320 PINpad:</b></p> <p>The customer took more than 30 seconds to respond to their prompts.</p> <ol style="list-style-type: none"> <li>1. Press the red  key on the iPP320.</li> <li>2. When the READY screen appears, try the transaction again.</li> </ol>
<b>REFUND LIMIT EXCEEDED</b>	<p>The total value of Refunds performed today is greater than your daily Refund Limit.</p> <p>Contact Moneris for a temporary increase in your daily Refund Limit. Please have the original Purchase receipt available for reference.</p>
<b>REINITIALIZATION REQUIRED</b>	Re-Initialize the terminal. See page 52.
<b>REMOVE AND INSERT CARD INTO PINPAD</b>	Remove the chip card from the iCT250, and insert it into the iPP320's chip reader.
<b>SWIPE ADMIN CARD</b>	You have manually entered a card number and expiry date while Manual Card Entry with Admin protection is enabled. Swipe your POS Admin card to continue the transaction.
<b>TAP FAILED PLEASE INSERT OR SWIPE CARD</b>	If the card has a chip, insert it into the iCT250 chip reader or iPP320 if attached; if the card does not have a chip, swipe it.

Message	Solution
<b>TIME-OUT</b> <b>or</b> <b>RETRY TERMINAL</b> <b>TIME-OUT</b>	<p>The customer took too long to respond to the prompts.</p> <ol style="list-style-type: none"> <li>1. If REMOVE CARD is also displayed, the customer removes their chip card.</li> <li>2. Retrieve the iCT250 or iPP320 if attached.</li> <li>3. Press the red  key on the iCT250.</li> <li>4. Retry the transaction when the READY screen appears.</li> </ol>
<b>TIP IS NOT</b> <b>SUPPORTED FOR</b> <b>MAIL/TEL</b>	<p>Do not enter a tip during a Mail Order/Telephone Order (MOTO) transaction.</p> <ol style="list-style-type: none"> <li>1. Press the green  key (or wait for the terminal) to return to the purchase amount confirmation screen.</li> <li>2. Respond to the prompts but, this time, do not enter a tip when the tip prompt appears. Simply leave it blank and press the green  key to continue.</li> </ol>
<b>TRANSACTION</b> <b>NOT FOUND</b>	<p>The terminal cannot find a matching transaction. This message appears for three seconds then the terminal returns to the previous prompt.</p>

## Equipment issues

Issue	Solution
<p><b>TCP CONNECTION FAILED</b></p> <p>or</p> <p><b>HOST CONNECTION FAILED</b></p>	<p>If the terminal is configured for dial:</p> <ol style="list-style-type: none"> <li>1. Confirm that the dial cable is securely plugged into the “ IN” port on the Magic Box.</li> <li>2. If the terminal must use a prefix to dial out, ensure that the dial PREFIX parameter has been configured correctly.</li> </ol> <p>If the terminal is configured for IP:</p> <ol style="list-style-type: none"> <li>1. Confirm that the Ethernet cable is securely plugged into the ETH port on the Magic Box.</li> <li>2. Check that the router and hub/switch (if any) are functioning (refer to the <b>IP Readiness Checklist</b> at <a href="http://moneris.com/checklist">moneris.com/checklist</a> to confirm that firewall rules have been updated).</li> <li>3. Confirm that the network is functioning. <ul style="list-style-type: none"> <li>▪ <b>Public Internet:</b> Contact your ISP (Internet service provider) for assistance.</li> <li>▪ <b>Corporate WAN:</b> Call your corporate help desk to confirm that the corporate WAN is functioning properly.</li> </ul> </li> </ol>
<p><b>You need to advance receipt paper from the printer.</b></p>	<p>While the terminal is powered on, press and hold down the yellow  key until the paper advances to the desired length.</p> <p><b>Note:</b> <i>If the lid is closed, DO NOT attempt to manually pull the paper from the printer as this will damage the printer.</i></p>
<p><b>The display screen is blank.</b></p>	<ol style="list-style-type: none"> <li>1. Check all cables to ensure that everything is plugged in correctly.</li> <li>2. If the screen is still blank, call Moneris Customer Care.</li> </ol>
<p><b>The Ethernet icon  at the top of the terminal screen is not coloured green.</b></p>	<p>If the terminal is configured to use Ethernet communication, see the solution for "TCP CONNECTION FAILED" above.</p>



# Merchant Support

At Moneris, help is always here for you 24/7.

## If you need assistance with your payment processing solution, we're here to help, 24/7.

We're only one click away.

- Visit [moneris.com/support](https://moneris.com/support) to:
  - watch the **iCT520 Setup and Installation** video
  - download additional copies of this guide and other resources
  - consult the **Moneris iCT250 WebHelp** for detailed information on all of the options available on your terminal and how to enable them
- Visit [shop.moneris.com](https://shop.moneris.com) to purchase point-of-sale supplies and receipt paper
- Visit [moneris.com/insights](https://moneris.com/insights) for business and payment news, trends, customer success stories, and quarterly reports & insights

### Need us on-site? We'll be there.

One call and a knowledgeable technician can be on the way. Count on minimal disruptions to your business as our Field Services provide assistance with your payment terminals.

### Can't find what you are looking for?

Call Moneris Customer Care (available 24/7) toll-free at **1-866-319-7450**. We'll be happy to help.

You can also send us a secure message 24/7 by logging in to Merchant Direct® at [moneris.com/mymerchantdirect](https://moneris.com/mymerchantdirect).



---

## BE PAYMENT READY

®MONERIS, MONERIS BE PAYMENT READY & Design and MERCHANT DIRECT are registered trade-marks of Moneris Solutions Corporation. All other marks or registered trade-marks are the property of their respective owners.

© 2017 Moneris Solutions Corporation, 3300 Bloor Street West, Toronto, Ontario, M8X 2X2. All Rights Reserved. This document shall not wholly or in part, in any form or by any means, electronic, mechanical, including photocopying, be reproduced or transmitted without the authorized consent of Moneris Solutions Corporation ("Moneris"). This manual is for informational purposes only. Neither Moneris nor any of its affiliates shall be liable for any direct, indirect, incidental, consequential or punitive damages arising out of use of any of the information contained in this manual. Neither Moneris or any of its affiliates nor any of our or their respective licensors, licensees, service providers or suppliers warrant or make any representation regarding the use or the results of the use of the information, content and materials contained in this manual in terms of their correctness, accuracy, reliability or otherwise. Your Gift card processing is governed by your Moneris Gift Program Agreement with Moneris. Your Loyalty card processing is governed by your Moneris Loyalty Program Agreement with Moneris. Your DCC processing is governed by your Moneris Dynamic Currency Conversion Agreement; and your credit and/or debit card processing is governed by the terms and conditions of the Moneris Merchant Agreement (the "Merchant Agreement") with Moneris. It is the merchant's responsibility to ensure that proper card processing procedures are followed at all times. Please refer to your Merchant manuals and the Terms and Conditions of your Merchant Agreement(s) for details. The *Moneris Merchant Operating Manual* is available at [moneris.com/support](https://moneris.com/support).