



BE PAYMENT READY

PAYD Pro Plus[®] Mobile Solution

Moneris[®] e355 PIN Pad

Quick Installation Guide

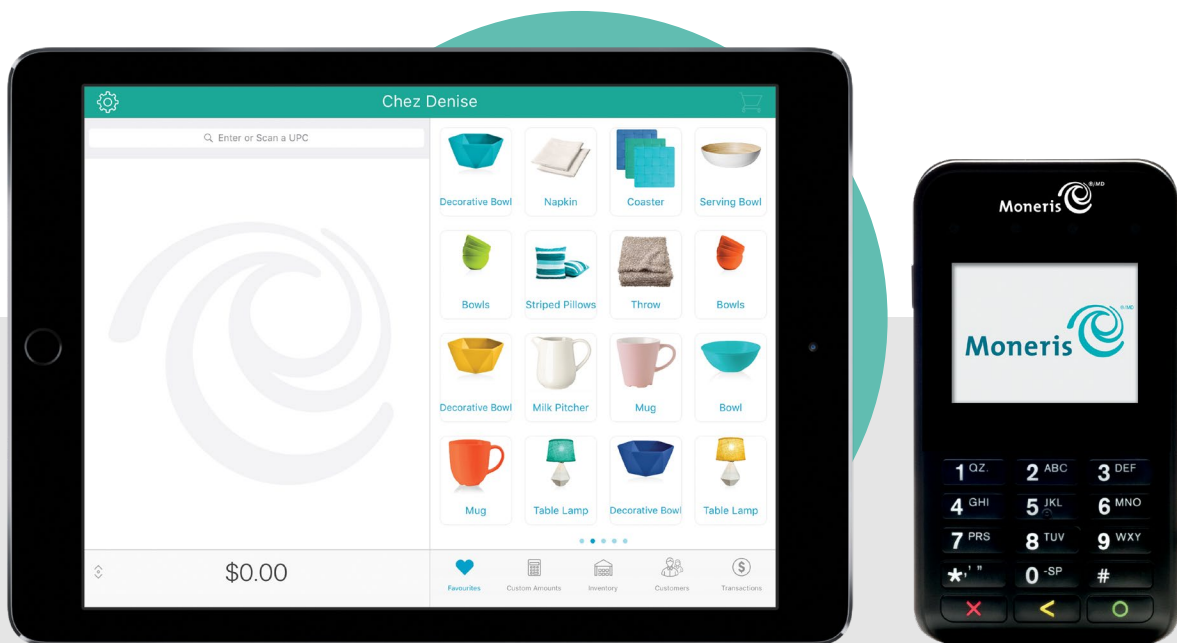



BE PAYMENT READY

Need help?

Web: moneris.com/support-PAYDProPlus-mobile

Toll-free: 1-855-423-PAYD (7293)

Record your Moneris merchant ID here:

Contents

Introduction	2
Before you get started.....	3
Learning about e355 basics	4
e355 best practices.....	6
Powering on the e355	6
Powering off the e355.....	6
Charging the e355.....	6
Charge indicator light.....	7
e355 conserving power in stand-by/sleep mode	7
Maintaining battery charge.....	7
Staying within communication range	7
Communication status indicators.....	8
Accessing PIN Pad configuration screens.....	8
e355 keyboard: entering numbers, letters, and special characters	8
Pairing an e355 PIN Pad with your Apple iPad.....	10
Pairing an e355 via Bluetooth.....	11
Unpairing the e355 PIN Pad	14
Pairing an e355 via Wi-Fi	15
Initializing the e355 PIN Pad.....	20
Switching e355 connections	21
Switching from Bluetooth to Wi-Fi	21
Switching from Wi-Fi to Bluetooth	22
Troubleshooting	23
Merchant support	24



Introduction

PAYD Pro Plus lets you turn your Apple® iPad® into a mobile POS payment solution, with great features that let you run your business from just about anywhere.

This guide explains how to pair and configure the Moneris e355 PIN Pad for the PAYD Pro Plus Mobile App on an Apple iPad.

Before you get started

1. Ensure that you have the following components:

- An Apple iPad that supports Bluetooth® and/or Wi-Fi connectivity.

Note: *If you want to pair the e355 via Wi-Fi, ensure that you have access to a secure (non-public) Wi-Fi network using WPA2 encryption.*

- e355 and USB charging cable (provided in your welcome kit).

Note: *You will be required to plug this cable into a powered USB port (e.g., on a computer).*

- The e355's terminal ID (also known as the "PIN Pad ID"), which is an 8-digit alpha-numeric code starting with "E1" (e.g., "E1012345") that is printed on a label affixed to the underside of the e355.

Important! You will be required to refer to this terminal ID during the setup procedures.



2. Ensure the PAYD Pro Plus App is downloaded and installed on your Apple iPad.

3. Proceed to *Learning about e355 basics* on page 4.

Learning about e355 basics



1. Familiarize yourself with the key elements of the e355:

1	Power indicator light (right side of the e355)
2	Micro-USB port (right side of the e355) <ul style="list-style-type: none"> ▪ Connect the USB charging cable here.
3	Cancel key (red)  <ul style="list-style-type: none"> ▪ Clear a displayed message, or cancel a transaction. ▪ Power off the e355 (press and hold down until the e355 beeps and starts to power off).
4	Correct key (yellow)  <ul style="list-style-type: none"> ▪ Clear data entered on the e355.

5	<p>OK/Enter key (green) </p> <ul style="list-style-type: none"> ▪ Submit data or acknowledge a message on the e355. ▪ Power on the e355 (press and hold down until the e355 starts to power up).
6	<p>Chip Reader (slot at the bottom of the e355)</p>
7	<p>Display Screen/Contactless Reader</p> <ul style="list-style-type: none"> ▪ The WELCOME/BONJOUR screen displays while the PIN Pad is idle.
8	<p>Magnetic Stripe Reader (slot along the top of the e355)</p>
9	<p>Contactless Reader Indicator (green flashing lights)</p>

2. Once you have familiarized yourself with the e355, follow the setup procedures for instruction on how to pair the e355 with your Apple iPad:
 - To pair the e355 via *Bluetooth*, proceed to page 11.
 - To pair the e355 via *Wi-Fi*, proceed to page 15.

e355 best practices

Moneris recommends that you follow these general guidelines to use and maintain your e355 PIN Pad.

Powering on the e355

Before you perform a PAYD Pro Plus transaction, confirm that the e355 is powered on by pressing the green  key and waiting for a response:

e355 response	e355 status
Beeps and displays the WELCOME/BONJOUR screen.	The e355 is fully powered on and awake; ready to do transactions.
Screen remains dark (the backlight is turned off completely).	The e355 is powered off and/or in sleep mode. Press and hold down the green  key until the e355 starts to power on.

Powering off the e355

To power off the e355, press and hold the red  key. Please note, this process can take several seconds.

Note: If the e355 is connected to power and charging, it will not power off. You will need to disconnect the cable from the e355 PIN Pad before attempting to power off.

Charging the e355

1. Plug the small end of the USB charging cable into the micro-USB port on the e355 (see page 4).

Important! Use the USB charging cable provided with the e355 PIN Pad. Failure to do so may affect the operability of, or cause damage to, the e355.

2. Plug the other end of the USB charging cable into a powered USB port (e.g., on a laptop or computer).





Note: It may take up to 3 hours to reach optimum charge depending on the battery's current charge status. The orange light above the micro-USB port will blink continuously while the battery is charging.

Note: The battery charge indicator displays on the e355's WELCOME/BONJOUR screen. If the e355 screen backlight is dim and/or "Moneris BE PAYMENT READY" displays during charging, simply press the green  key to return to the WELCOME/BONJOUR screen.

3. Once the battery has reached optimum charge (at least 90%), you may disconnect the USB charging cable.



Charge indicator light

The charge indicator light is located on the right side of the e355 PIN Pad (see page 4). The colour of the light indicates the charge level of the e355. If the e355 is powered off or it is powered on but goes into a sleep/stand-by state to conserve power (see below), the charge indicator light will turn off.

Light colour		Description
Orange		Battery is charging (blinking light).
Green		Battery charge is moderate to high.
Yellow		Battery charge is moderate to low.
Red		Battery charge is low. Connect the e355 to a power source.

e355 conserving power in stand-by/sleep mode

If the e355 is powered on but not being used to perform transactions, it will go into an idle state to conserve power (the e355 screen backlight dims and/or "Moneris BE PAYMENT READY" displays).

If you do not initiate a transaction from the PAYD Pro Plus App or press the green  key /the red  key on the e355 keypad, and:

Bluetooth is enabled:

- The e355 will go into a sleep/stand-by state (the screen backlight will turn off completely) for up to several hours, and then the e355 will shut down/power off completely.

Wi-Fi is enabled:

- The e355 will remain in its idle state for as long as the battery is sufficiently charged.

Note: If the e355 loses its connection with the Apple iPad for up to 15 minutes (e.g., the e355 is outside its Bluetooth communication range/cannot connect to the Wi-Fi network), the e355 will shut down/power off completely.

Maintaining battery charge

- When you are not using the e355 (e.g., at night), connect it to a power source via the USB charging cable, and leave the e355 to recharge to full capacity.

OR





- Power off the e355 by pressing and holding down the red  key until the e355 beeps and starts to shutdown/power off (ensure that the USB charging cable is not connected to a power source).

Staying within communication range

- Keep the e355 and your Apple iPad in close proximity to each other.
- Do not attempt to perform PAYD Pro Plus transactions near strong sources of electromagnetic interference.

Communication status indicators

The indicators shown below should display on your e355's WELCOME/ BONJOUR screen when you are ready to perform transactions.

Communication type	e355 screen status indicators
Bluetooth	  < Your mobile device name > AA% 
Wi-Fi	 < Your Wi-Fi network SSID > AA% 

Accessing PIN Pad configuration screens

If you need to access the configuration screens again, press the **1** key and the yellow  key at the same time.

e355 keyboard: entering numbers, letters, and special characters

Press the e355 keys to enter numbers, letters, and special symbols.

- To enter the desired value in a data field, press the key that corresponds to the value that you want to enter (press the key repeatedly as necessary until the desired value is displayed in the field. Refer to the table below for the full list of corresponding values.)
- Once a value is successfully entered, proceed to enter the next value.

Note: The SSID (network name) and password parameters are case sensitive (i.e., if your network SSID and password contain capital and small letters, you must enter capital and small letters in the data fields).

- To delete/correct the last entered value, press the yellow  key.

Key	Enters this value
1	1, Q, Z, <period>, q, z
2	2, A, B, C, a, b, c
3	3, D, E, F, d, e, f
4	4, G, H, I, g, h, i
5	5, J, K, L, j, k, l
6	6, M, N, O, m, n, o
7	7, P, R, S, p, r, s
8	8, T, U, V, t, u, v
9	9, W, X, Y, w, x, y

Key	Enters this value
0	0, *, #, <period>, -, <space>, +, <comma>, ', ", !, :, ;, @, =, &, /, \, %, \$, (,), ^, _

For example, to enter the word “Moneris”, use the following sequence:

Letter	Enter this value
M	6, 6
o	6, 6, 6, 6, 6, 6, 6
n	6, 6, 6, 6, 6, 6
e	3, 3, 3, 3, 3, 3
r	7, 7, 7, 7, 7, 7
i	4, 4, 4, 4, 4, 4, 4
s	7, 7, 7, 7, 7, 7, 7

Pair Apple iPad

Pairing an e355 PIN Pad with your Apple iPad

In this section, we go over everything you need to know to pair your e355 PIN Pad with an Apple iPad.

Pairing an e355 via Bluetooth

Follow the steps below to pair the e355 via Bluetooth.

Important! Before you begin this setup procedure, ensure that the PAYD Pro Plus App is closed so that it is not running in the background on your Apple iPad.

1. Power on the e355:
 - a. Plug the small end of the USB charging cable into the micro-USB port on the e355 (see page 4).



Important! Use the USB charging cable provided with the e355. Failure to do so may affect the operability of, or cause damage to, the e355.
 - b. Plug the other end of the USB charging cable into a powered USB port (e.g., on a laptop or computer).

Note: Leave the USB charging cable connected to the e355 for the remainder of the setup process.
 - c. Wait while the e355 powers on.
 - d. When the LANGUAGE/LANGUE screen appears, proceed to step 2.
2. Ready your Apple iPad for Bluetooth pairing:
 - a. Power on your Apple iPad to which you want to pair the e355.
 - b. Ensure that Bluetooth is turned on, that the iPad is discoverable, and its Bluetooth settings screen is displayed.

Note: If the Apple iPad has ever been paired with a different e355 or another type of PIN Pad (e.g., a PAYD PIN Pad), ensure that the iPad does not continue to retain the other PIN Pad's terminal ID in its Bluetooth memory (i.e., if necessary, un-pair the other PIN Pad from the Apple iPad so that it forgets the terminal ID). Refer to Unpairing the e355 PIN Pad on page 14 for more information.
 - c. Place the Apple iPad beside the e355 with which you want to pair.
3. Configure the e355 for Bluetooth communication:
 - a. On the LANGUAGE/LANGUE screen, press the **1** key to select **ENGLISH**.
 - b. When the TERMINAL SETUP screen appears, press the **1** key to select **Communication**.
 - c. When the COMMUNICATION screen appears, press the **1** key to select **PAYD Family**.
 - d. When the ECR CONNECTION screen appears, press the **2** key to select **Bluetooth**.
 - e. When the ECR OS screen appears, press the **1** key to select **iOS**.
 - f. When the Bluetooth screen appears, proceed to step 4.
4. Pair the e355 with your Apple iPad via Bluetooth:
 - a. On the Bluetooth screen, press the green  key to select **Add device**.
 - b. Wait while the e355 searches for devices with which to pair.

- c. When the Add device screen displays, scroll to your iPad name, and press the green  key to select it.

Note: To scroll up, press the **2** key; to scroll down, press the **5** key. If your iPad name is not listed, press the yellow  key, and return to step 4a.

- d. When the Pair device screen appears, press the **3** key to select **Yes**.
- e. When the Pairing screen displays, wait while the passkey is generated.
- f. When the Please compare screen appears, note the six-digit passkey.
- g. On your Apple iPad, wait for the “Bluetooth pairing request” popup to appear. This popup will include a six-digit passkey/code.
- h. Compare the passkey displayed on the e355 and the passkey on the Apple iPad.
 - If the passkeys are *identical*, go to the next step.
 - If the passkeys are *different*, power off the e355 PIN Pad (press and hold down the red  key until it powers down), power it back up and repeat steps 3 and 4.
- i. Tap **Pair** on the Apple iPad’s “Bluetooth Pairing Request” popup. On the e355, press the **3** key to select **Yes**.
- j. When the Paired screen appears, press the green  key to select **OK**.
- k. When the REBOOT TERMINAL screen displays, wait while the e355 reboots.
- l. Wait while the e355 re-establishes its Bluetooth connection with the iPad (during this period, the WELCOME/BONJOUR NOT CONNECTED screen displays).
- m. Proceed to step 5.

5. Confirm that your Apple iPad is successfully paired with the e355:

- a. When the CONNECTED TO BT <your iPad name> screen displays, it means the e355 has successfully established a Bluetooth connection with your Apple iPad.

Note: As long as the e355 can detect the Apple iPad, the iPad’s name will display at five-second intervals at the top centre of the e355 screen (otherwise the e355’s internal clock time will display). The clock time will be synchronized to the correct time when you initialize the e355.

- b. When the WELCOME/BONJOUR screen appears, proceed to the next step.
- c. On your Apple iPad’s Bluetooth settings screen, locate the e355’s 8-digit terminal ID, which displays with the prefix "e355-" as in "e355-E1012345" (or sometimes the terminal ID may display simply as "Verifone BTx Host").

Note: The e355’s terminal ID (e.g., "E1012345") is also printed on a label affixed to the underside of the e355.

- d. On your Apple iPad’s Bluetooth settings screen, confirm that the terminal ID (or "Verifone BTx Host") is shown as a "Connected" device.

6. Log in to the PAYD Pro Plus App using your PAYD login credentials (Username, Password, and Store ID), your Quick PIN, or your fingerprint (using Touch ID).

7. Tap the **Settings** button ().
8. On the main menu, tap **Configuration**.
9. On the Configuration screen, tap **Devices**.
10. On the Devices screen, in the **PIN PAD** section, toggle the **Enable PIN Pad** switch to the right (Enabled).
11. Tap **Setup**.
12. In the PIN Pad Configuration popup, in the CONNECTION TYPE section, tap **Bluetooth**.

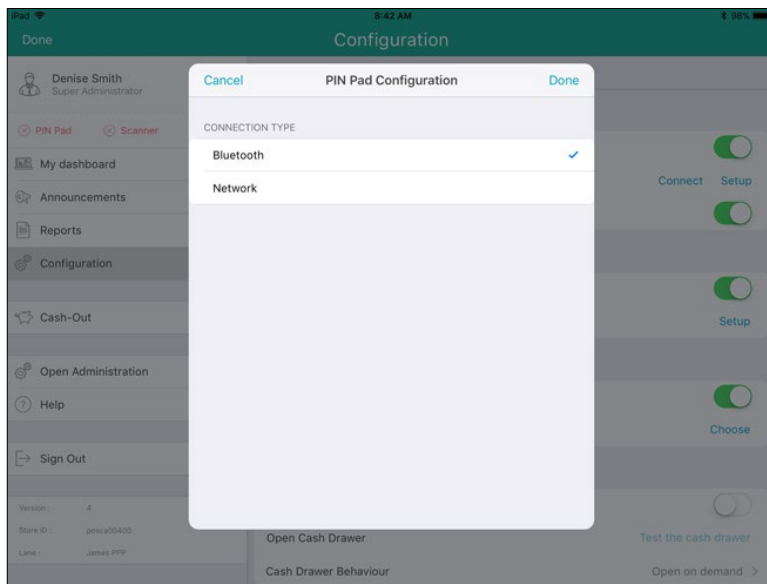

13. Tap **Finish** at the top of the PIN Pad Configuration popup.
 “Connecting to PIN Pad” appears on the screen, then the Configuration – Devices screen appears.

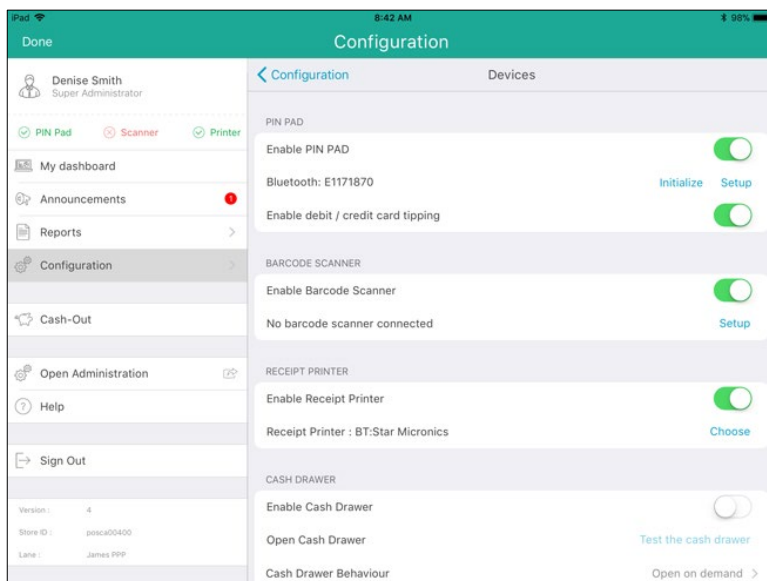

14. Do one of the following:



- To enable tip prompts to be displayed on the PIN Pad when customers use *Interac* debit and credit cards, toggle the **Enable debit/credit card tipping** switch to the right (Default = Disabled).
- To not display tipping prompts, leave the **Enable debit/credit card tipping** switch toggled to the left (Disabled).

15. Proceed to *Initializing the e355 PIN Pad* on page 20.

Unpairing the e355 PIN Pad

It may become necessary to unpair the e355 from your Apple iPad in order to pair it to another Apple iPad. Use the steps below as a guide for performing this task.

Note: *You should only have one PIN Pad paired via Bluetooth at a time.*

1. Log out of the PAYD Pro Plus App.
2. Tap the **Settings** icon () on the Apple iPad's main screen.
3. In the Settings menu, tap **Bluetooth**.
4. In the Bluetooth menu, in the MY DEVICES list, tap the **Info** icon () next to the PIN Pad name (e.g., "e355-E1123456").
5. Tap **Forget This Device**.
A confirmation popup appears.
6. Tap **OK**.

The Bluetooth menu reappears, and the e355 PIN Pad is removed from the MY DEVICES list.

Pairing an e355 via Wi-Fi

Follow the steps below to pair the e355 via Wi-Fi.

Important! Before you begin this setup procedure, ensure that the PAYD Pro Plus App is closed so that it is not running in the background on your Apple iPad.

1. Power on the e355:
 - a. Plug the small end of the USB charging cable into the micro-USB port on the e355 (see page 4).

Important! Use the USB charging cable provided with the e355. Failure to do so may affect the operability of, or cause damage to, the e355.
 - b. Plug the other end of the USB charging cable into a powered USB port (e.g., on a laptop or computer).

Note: Leave the USB charging cable connected to the e355 for the remainder of the setup process.
 - c. Wait while the e355 powers on.
 - d. When the LANGUAGE/LANGUE screen appears, proceed to step 2.
2. Ready your Apple iPad for Wi-Fi pairing:
 - a. Power on your Apple iPad to which you want to pair the e355.
 - b. Determine which is the network that you want to use to pair the e355 with the Apple iPad:
 - If you want the Apple iPad to connect an external Wi-Fi network, configure the iPad to connect to the network.

Note: In the upcoming steps, you will be instructed to configure the e355 to connect to the same Wi-Fi network as the mobile device.



Important! Do not attempt to configure the e355 to connect to a public Wi-Fi network.
 - If you want the e355 to connect to the Apple iPad's personal Wi-Fi hotspot, generate the hotspot from the iPad now.
 - c. Place the Apple iPad beside the e355 with which you want to pair.
 - d. Proceed to step 3.
3. Configure the e355 for Wi-Fi communication:
 - a. On the LANGUAGE/LANGUE screen, press the **1** key to select **ENGLISH**.
 - b. When the TERMINAL SETUP screen appears, press the **1** key to select **Communication**.
 - c. When the COMMUNICATION screen appears, press the **1** key to select **PAYD Family**.
 - d. When the ECR CONNECTION screen appears, press the **1** key to select **WiFi**.



- e. When the WiFi screen displays, create a profile for the Wi-Fi network to which you want the e355 to connect:
 - To manually enter the Wi-Fi network name (SSID), proceed to step 4.
 - To scan for the Wi-Fi network name (SSID), proceed to step 5.

Note: Use the scan option only if you are certain that the desired Wi-Fi network is broadcasting its SSID.

4. Manually enter the Wi-Fi network name (SSID):

- a. On the WiFi screen, press the **1** key to select **New**.

Note: If you have already configured a Wi-Fi network profile, it will be listed on this screen.
- b. When the View/Edit screen appears, press the green  key to select **SSID**.
- c. When the SSID screen displays, enter the name/SSID of the Wi-Fi network to which you want the e355 to connect, and press the  key.

Note: This parameter is case-sensitive. To enter the small/capital letters and special symbols, see page 8.
- d. When the View/Edit screen appears, press the **5** key to scroll to **Wi-Fi Password** and press the green  key.
- e. When the WiFi Password screen displays, enter the password of the Wi-Fi network to which you want the e355 to connect, and press the green  key.

Note: This parameter is case-sensitive. To enter the small/capital letters and special symbols, see page 8.
- f. When the View/Edit screen appears, press the **3** key to select **Save**.
- g. When the Configure Interface screen appears, wait while the e355 applies the network settings.
- h. When the Accepted screen appears, press the green  key.
- i. Wait while the e355 establishes its connection to the Wi-Fi network (during this period, the WELCOME/BONJOUR NOT CONNECTED screen displays).

The CONNECTED TO WI-FI <Your Wi-Fi network SSID> screen appears, displaying your network SSID and the e355's IP address.
- j. When the WELCOME/BONJOUR screen appears, proceed to step 6.

5. Scan for the SSID:

- a. On the WiFi screen, press the **3** key to select **WiFi Scan**.
- b. When the WiFi Scan screen displays, wait while the e355 scans for available Wi-Fi networks.
- c. When the list of available Wi-Fi networks displays, scroll to the Wi-Fi network to which you want the e355 to connect, and press the green  key to select it.



Note: To scroll up, press the **2** key; to scroll down, press the **5** key. If your Wi-Fi network is not listed, press the yellow  key, and return to step 5a of this procedure.
- d. When the next screen displays your Wi-Fi network profile settings, press the **3** key to select **Add**.

- e. When the Wi-Fi Password screen appears, enter the password for your Wi-Fi network and press the green  key.

Note: This parameter is case-sensitive. To enter the small/capital letters and special symbols, see page 8.

- f. When the Configure Interface screen appears, wait while the e355 applies the network settings.
- g. When the Accepted screen appears, press the green  key.

Note: If the Internal error screen appears, press the green  key and go back to step 5a of this procedure.

Note: If the Failed: Wifi already present screen displays, press the green  key to clear the error screen, and then press the red  key twice.

- h. Wait while the e355 establishes its connection to the Wi-Fi network (during this period, the WELCOME/BONJOUR NOT CONNECTED screen displays).

The CONNECTED TO WI-FI <Your Wi-Fi network SSID> screen appears, displaying your network SSID and the e355's IP address.

- i. When the WELCOME/BONJOUR screen appears, proceed to step 6.

6. On the WELCOME/BONJOUR screen, confirm that the Wi-Fi icon () is displayed in the upper left corner of the screen, and your Wi-Fi network SSID is displayed at the top centre of the screen.

The network icon () may display periodically beside the Wi-Fi icon.

Note: As long as the e355 can connect to the Wi-Fi network, the network SSID will display at five-second intervals at the top centre of the e355 screen (otherwise the e355's internal clock time will display). The clock time will be synchronized to the correct time when you initialize the e355.

7. Log in to the PAYD Pro Plus App using your PAYD login credentials (Username, Password, and Store ID), your Quick PIN, or your fingerprint (using Touch ID).

8. Tap the **Settings** button ()

9. On the main menu, tap **Configuration**.

10. On the Configuration screen, tap **Devices**.

11. On the Devices screen, in the **PIN PAD** section, toggle the **Enable PIN Pad** switch to the right (Enabled).

12. Tap **Setup**.

13. In the PIN Pad Configuration popup, in the **CONNECTION TYPE** section, select **Network**.

14. In the NETWORK ADDRESS section, tap **Search**.

The PIN Pad Search popup appears.

Note: It is possible to also manually enter a network (IP) address. Refer to the **PAYD Pro Plus Online Help** for information on performing this task.

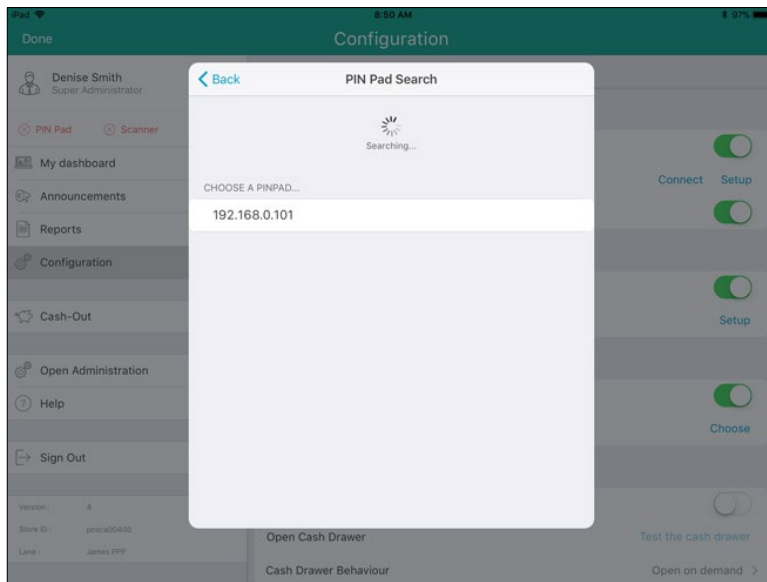

15. In the PIN Pad Search popup, tap the IP address of the e355 you paired with the iPad, then tap **<Back** at the top of the popup.

The PIN Pad Configuration popup appears with the IP Address fields populated.

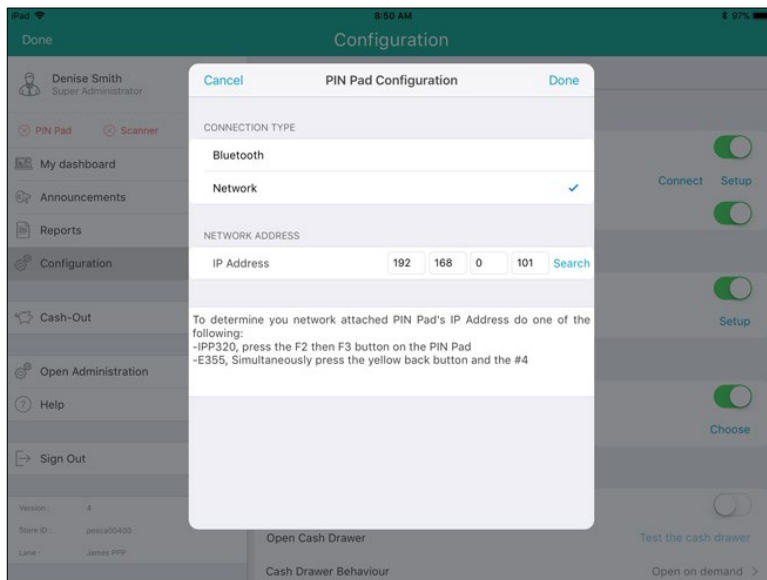

16. Tap **Finish** at the top of the PIN Pad Configuration popup.

The screen displays “Connecting to PIN Pad”, then the Configuration – Devices screen reappears.

17. Do one of the following:

- To enable tip prompts to be displayed on the PIN Pad when customers use *Interac* debit and credit cards, toggle the **Enable debit/credit card tipping** switch to the right (Default = Disabled).
- To not display tipping prompts, leave the **Enable debit/credit card tipping** switch toggled to the left (Disabled).

18. Proceed to *Initializing the e355 PIN Pad* on page 20.

Initializing the e355 PIN Pad

Follow the steps below to select the e355 PIN Pad in the PAYD Pro Plus App, then initialize the PIN Pad.

1. In the Configuration – Devices screen, in the PIN PAD section, tap **Initialize**.
A warning popup appears informing you the initialization could take several minutes.
2. Tap **Yes** to proceed.
The PAYD Pro Plus App displays “Initializing PIN Pad” and the PIN Pad displays “PLEASE WAIT”.
3. Wait while the PIN Pad initializes. Once complete, the message “PIN Pad has been successfully initialized” appears on the iPad. Tap the **OK** button.

The e355 PIN Pad returns to the WELCOME/BONJOUR screen and the PAYD Pro Plus App returns to the Configuration – Devices screen.

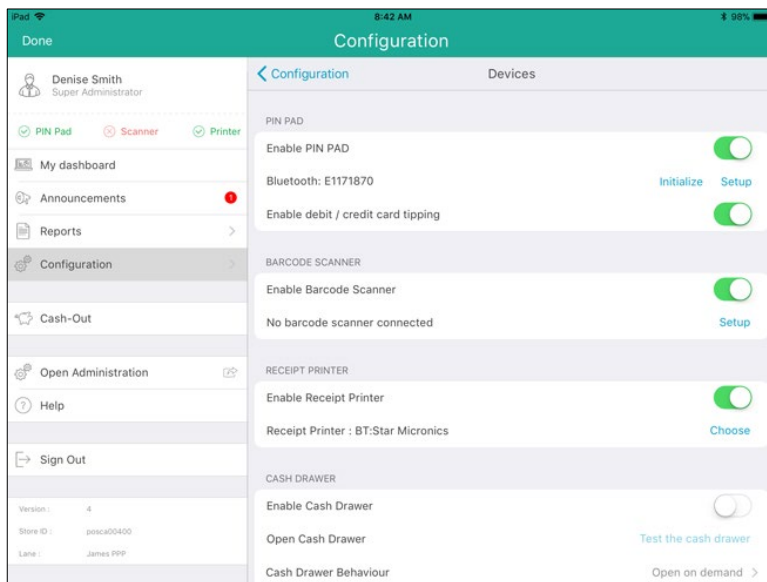





Congratulations! You are now ready to process *Interac* debit and credit card transactions with your PAYD Pro Plus App and the e355 PIN Pad.

Switching e355 connections

You may need to remove a connection in order to connect via another method. For example, you initially configured a Bluetooth connection, but now wish to switch to a Wi-Fi connection instead. Follow the steps below to manage the connections.



Switching from Bluetooth to Wi-Fi

1. Log out of PAYD Pro Plus.
2. On your Apple iPad, disable Bluetooth communication for the moment.
 - a. Tap the **Settings** icon () on the Apple iPad's main screen.
 - b. In the Settings screen, tap **Bluetooth**.
 - c. In the Bluetooth screen, toggle the **Bluetooth** switch to the left (Disabled).
 - d. Proceed to step 3.
3. Access the e355 configuration screen (see page 6 for instructions).
4. On the LANGUAGE/LANGUE screen, press the **1** key to select **ENGLISH**.
5. When the TERMINAL SETUP screen appears, press the **1** key to select **Communication**.
6. When the COMMUNICATION screen appears, press the **1** key to select **PAYD Family**.
7. At the ECR CONNECTION screen, press the **2** key to select **Bluetooth**.
8. At the ECR OS screen, press the **1** key to select **iOS**.
9. At the Bluetooth screen, press the **5** key to scroll down and select **Manage devices**, then press the green  key.
10. In the Manage devices screen, your iPad name is highlighted. Press the green  key to select it.
11. In the <your iPad name> screen, press the **5** key to scroll down and select **Remove**, then press the green  key.

The e355 processes the request and then the Remove OK screen appears.
12. Press the green  key.



The No devices screen appears.
13. On the Apple iPad, enable Bluetooth again in the Bluetooth screen.
14. Power off the e355 PIN Pad (see page 6).
15. Power on the e355 PIN Pad (see page 6).
16. Access the e355 configuration screen (see page 6).
17. Begin the process of connecting via Wi-Fi. See *Pairing an e355 via Wi-Fi* on page 15 for more information.

Switching from Wi-Fi to Bluetooth

1. Log out of PAYD Pro Plus.
2. Ensure Bluetooth is enabled and that your iPad is discoverable by other Bluetooth devices.
3. Access the e355 configuration screen (see page 6 for instructions).
4. On the LANGUAGE/LANGUE screen, press the **1** key to select **ENGLISH**.
5. When the TERMINAL SETUP screen appears, press the **1** key to select **Communication**.
6. When the COMMUNICATION screen appears, press the **1** key to select **PAYD Family**.
7. At the ECR CONNECTION screen, press the **1** key to select **WiFi**.
8. In the WiFi screen, the network SSID is highlighted. Press the green  key to select it.
9. In the <your network name> screen, press the **5** key to scroll down and select **Remove network**, then press the green  key.
The e355 processes the request and then the WiFi screen appears empty.
10. Press the red  key.
The WELCOME/BONJOUR screen appears.
11. Power off the e355 PIN Pad (see page 6).
12. Power on the e355 PIN Pad (see page 6).
13. Access the e355 configuration screen (see page 6).
14. Begin the process of connecting via Bluetooth. See *Pairing an e355 via Bluetooth* on page 11 for more information.

Troubleshooting

If a problem occurs and is listed in the table below, follow the instructions in the table. If the problem is still not resolved, call Moneris Customer Care toll-free at [1-866-319-7450](tel:1-866-319-7450).

Issue	Solution
The e355 screen is black.	The e355 may be powered off, or conserving battery life in sleep mode. Press and hold the green  key to power it on (or revive from sleep mode).
The e355 PIN Pad is paired to the iPad and appears “Connected” in the iPad’s Bluetooth menu, but in the PAYD Pro Plus App, it appears as “Not connected” ().	<p>The e355 PIN Pad may need to refresh its connection to the Apple iPad. Follow these steps to address the issue:</p> <ol style="list-style-type: none"> 1. Power off the e355 PIN Pad (see page 6). 2. Power on the e355 PIN Pad (see page 6). <p>If this doesn’t work, it may need to be “unpaired” and “re-paired” to the iPad.</p> <ol style="list-style-type: none"> 1. Power off the e355 PIN Pad (see page 6). 2. Follow the steps in <i>Unpairing the e355 PIN Pad</i> on page 14. 3. Power on the e355 PIN Pad (see page 6). 4. Access the e355 configuration screen (see page 6). 5. Follow the steps in <i>Pairing an e355 via Bluetooth</i> on page 11.
“PIN Pad initialization error.”	Tap OK , then contact Moneris Customer Care toll-free at 1-855-423-PAYD (7293) .



Merchant support

At Moneris, help is always here for you 24/7.

If you need assistance with your payment processing solution, we're here to help, 24/7.

We're only one click away.

- Visit moneris.com/support-PAYDProPlus-mobile to:
 - consult the FAQs on how to set up and use PAYD Pro Plus
 - download PAYD Pro Plus guides to assist with getting started, hardware installation, configuration, and usage instructions
- Visit shop.moneris.com to purchase point-of-sale supplies and receipt paper
- Visit moneris.com/insights for business and payment news, trends, customer success stories, and quarterly reports & insights

Need us on-site? We'll be there.

Moneris offers quick, hassle-free on-site setup of your complete iPad POS Solution by our in-house technicians. Contact us at **1-866-MONERIS** or visit moneris.com/iPadPOS to learn more.

Can't find what you are looking for?

Call Moneris Customer Care (available 24/7) toll-free at **1-866-319-7450**. We'll be happy to help.

You can also send us a secure message 24/7 by logging in to Merchant Direct® at moneris.com/mymerchantdirect.



BE PAYMENT READY

MONERIS, MONERIS BE PAYMENT READY & Design and MERCHANT DIRECT are registered trade-marks of Moneris Solutions Corporation. MONERIS PAYD PRO PLUS is a registered trade-mark of Moneris Solutions Corporation. APPLE and IPAD are trade-marks of Apple Inc., registered in the U.S. and other countries. All other marks or registered trade-marks are the property of their respective owners.

© 2019 Moneris Solutions Corporation, 3300 Bloor Street West, Toronto, Ontario, M8X 2X2. All Rights Reserved. This document shall not wholly or in part, in any form or by any means, electronic, mechanical, including photocopying, be reproduced or transmitted without the authorized consent of Moneris Solutions Corporation. This document is for informational purposes only. Neither Moneris Solutions Corporation nor any of its affiliates shall be liable for any direct, indirect, incidental, consequential or punitive damages arising out of use of any of the information contained in this document. Neither Moneris Solutions Corporation or any of its affiliates nor any of our or their respective licensors, licensees, service providers or suppliers warrant or make any representation regarding the use or the results of the use of the information, content and materials contained in this document in terms of their correctness, accuracy, reliability or otherwise. This document has not been authorized, sponsored, or otherwise approved by Apple Inc.

Your credit and/or debit card processing is governed by the terms and conditions of your agreement for PAYD credit/debit card processing services with Moneris Solutions Corporation. It is your responsibility to ensure that proper card processing procedures are followed at all times. Please refer to the ***Moneris Merchant Operating Manual*** (available at: moneris.com/support) and the terms and conditions of your applicable agreement(s) for credit/debit processing or other services with Moneris Solutions Corporation for details.