

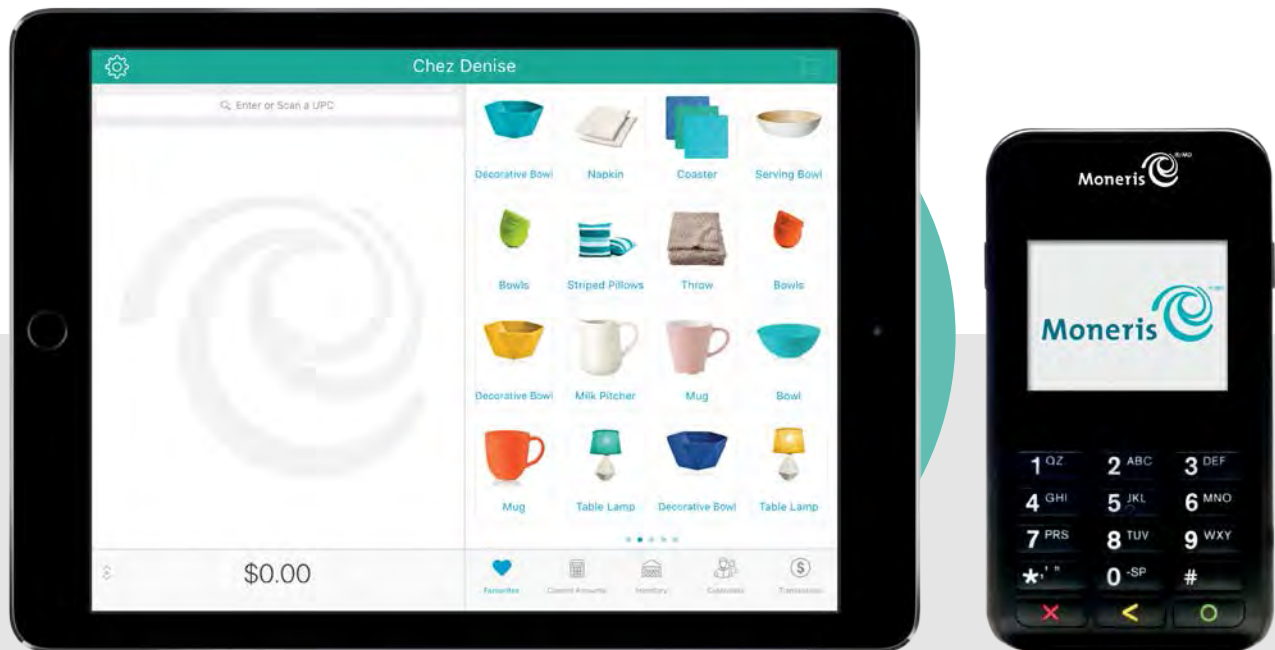

BE PAYMENT READY

# PAYD Pro Plus<sup>®</sup> Mobile Solution

## Using PAYD Pro Plus for Apple<sup>®</sup> iPad<sup>®</sup>





---

**BE PAYMENT READY**

## Need help?

Web: [moneris.com/support-PAYDProPlus-mobile](https://moneris.com/support-PAYDProPlus-mobile)

Toll-free: 1-855-423-PAYD (7293)

Record your Moneris® merchant ID here:

---

# Contents

- Introduction .....5**
- Signing in and out.....6**
  - Signing into the PAYD Pro Plus App.....6
  - Navigating the interface .....7
    - Accessing the main menu .....7
    - The panes.....7
    - The on-screen keyboard and numberpad .....7
  - Signing out.....8
  - Cashing in.....8
- Enroll in Merchant Direct® .....10**
- Inventory management .....11**
  - Adding new products.....12**
  - Searching inventory.....15**
    - Searching for a product .....15
    - Searching for all products.....15
  - Editing products .....16**
  - Deleting products .....18**
- Customer management .....19**
  - Adding new customers .....20**
  - Searching customers.....23**
    - Searching for a customer.....23
    - Searching all customers.....23
  - Editing a customer profile.....25**
  - Deleting customers.....26**
- The Favourites Group .....27**
  - Adding products to the Favourites Group.....28**
  - Removing products from the Favourites Group .....30**
  - Adding a customer to the Favourites Group .....31**
  - Editing the contents of the Favourites Group .....32**
- Processing transactions .....33**
  - Before you get started.....34**
    - General guidelines for performing a transaction .....35
  - Processing sales.....36**

Processing a sale without assigning a customer .....	36
Assigning a customer to a sale .....	36
Searching for customers .....	36
Creating a new customer profile .....	37
Adding a customer from the Favourites Group .....	37
Adding products to a sale .....	37
Scanning products .....	38
Searching for products.....	38
Adding products from the Favourites Group.....	38
Adding non-inventory items to a sale.....	39
Editing quantities and prices .....	39
Adjusting item quantity .....	39
Adjusting product price .....	40
Removing products from the shopping cart of items.....	41
Applying discounts.....	41
The Custom Amounts function.....	45
Using the Custom Amounts function.....	45
<b>Suspending and resuming transactions .....</b>	<b>47</b>
Suspending a transaction .....	47
Resuming suspended transactions.....	48
Discarding suspended transactions.....	48
<b>Cancelling transactions.....</b>	<b>50</b>
<b>Processing payment .....</b>	<b>51</b>
Reassigning commission.....	51
Processing cash payment .....	52
Processing cheque payment.....	53
Card entry options.....	53
Insert: chip cards.....	53
Swipe: magnetic stripe cards.....	54
Wave/tap: Contactless cards.....	54
Maximum Contactless Dollar Value (CDV).....	55
Swipe: magnetic stripe cards on the PAYD Card Reader .....	55
Manual card entry .....	56
Processing Interac Debit payments.....	56
Integrated debit payments.....	56
Processing credit card payments.....	57
Integrated credit payments.....	57
Processing Store Credit payments.....	59
Processing a Store Credit belonging to a registered customer.....	59
Processing a Store Credit that belongs to an unregistered customer .....	59
Processing split-tender payments .....	60
Processing Moneris gift cards.....	61
<b>Processing layaways .....</b>	<b>62</b>
Putting items on layaway .....	62
Taking layaway deposits.....	63
Making layaway payments .....	64

Finalizing a layaway .....	66
Refunding layaway payments and transactions .....	67
Refunding layaway deposits and payments .....	67
Refunding completed layaway transactions.....	68
Cancelling layaways.....	69
Layaway receipts .....	69
<b>Processing invoices.....</b>	<b>71</b>
Activating the invoicing feature .....	71
Setting invoice options .....	71
Producing an invoice .....	71
Editing invoice details.....	73
Sending invoices to the customer .....	74
Sending invoices via email .....	74
Sending invoices via SMS text.....	75
Changing sent invoices .....	75
Cancelling invoices.....	77
Customer invoice payment.....	78
Paying the invoice in person.....	78
Paying the invoice from an emailed link.....	79
Paying the invoice from an SMS text.....	80
Refunding invoices.....	82
Refunding invoice payments .....	83
Refunding a completed invoice .....	83
<b>Receipt options .....</b>	<b>84</b>
Generating printed receipts .....	84
Generating email receipts .....	84
Generating SMS text receipts.....	85
Generating gift receipts.....	86
Reprinting transaction receipts .....	87
<b>Optional devices.....</b>	<b>89</b>
The Moneris e355 PIN Pad .....	89
The Moneris iPP320 PIN Pad .....	91
The Moneris PAYD® PIN Pad .....	93
Determining the PAYD PIN Pad software version.....	94
The Moneris PAYD card reader .....	95
Bluetooth barcode scanner .....	95
Bluetooth receipt printer.....	96
Dymo LabelWriter .....	96
<b>Customer prompts on the PIN Pads.....</b>	<b>97</b>
Customer prompts on the e355 PIN Pad.....	97
Customer prompts on the iPP320 and PAYD PIN Pads .....	99
<b>Administrative transactions.....</b>	<b>101</b>
<b>Accessing Help .....</b>	<b>102</b>
<b>Accessing PAYD Administration .....</b>	<b>103</b>

<b>Changing the automatic logout time .....</b>	<b>104</b>
Logging in after session lock .....	105
Logging in after automatic logout .....	106
<b>Processing Payouts .....</b>	<b>107</b>
<b>Searching transactions.....</b>	<b>110</b>
<b>Checking Bluetooth device status.....</b>	<b>112</b>
<b>Generating reports .....</b>	<b>113</b>
<b>Using the Dashboard .....</b>	<b>114</b>
Viewing the Dashboard data .....	114
<b>Processing a Return .....</b>	<b>116</b>
<b>End of day procedures .....</b>	<b>120</b>
Cashing out .....	120
<b>Troubleshooting .....</b>	<b>122</b>
Error messages in the PAYD Pro Plus App .....	122
Error messages on the PIN Pads .....	124
Other issues (PIN Pads).....	126
<b>Merchant support.....</b>	<b>128</b>



# Introduction

PAYD Pro Plus<sup>®</sup> lets you turn your Apple<sup>®</sup> iPad<sup>®</sup> into a mobile POS Payment Solution, with great features that let you run your business from just about anywhere.

This guide provides you with instructions on how to use the PAYD Pro Plus App to manage inventory, gain insights into customer buying trends, and process transactions.

# Signing in and out

## Signing into the PAYD Pro Plus App

Depending on how the PAYD Pro Plus App has been configured, you may be required to sign in with your Moneris PAYD® credentials (**Employee ID**, **Password**, and **Store ID**), sign in with your fingerprint using **Touch ID**, or you may need to enter a **Quick PIN**.

### To sign in using the standard login screen:

1. Enter your user name (Employee ID) into the **Employee ID** field.
2. Enter your password into the **Password** field.
3. Enter your store's ID into the **Store ID** field.
4. Tap **Sign In**.

The Sale screen appears.

### To sign in using a quick PIN:

1. Tap the **Employee ID** drop-down menu and tap the checkmark next to your name.
2. Enter your PIN into the **Type in your Quick PIN** field.

The Sale screen appears.

### To sign in using your fingerprint (Touch ID):

1. At the Sign In screen, tap **Use Touch ID**.
2. At the **Touch ID** prompt, touch or press the **Home** button on the Apple iPad.

The Sale screen appears.

**Note:** Based upon your PAYD Pro Plus software bundle type and/or your Merchant Agreement with Moneris, certain features described in this guide may not be visible within the PAYD Pro Plus App.



## Navigating the interface

**Note:** The PAYD Pro Plus App will always appear in “landscape” orientation, even if the Apple iPad is tilted into a “portrait” orientation.

### Accessing the main menu

- To access the main menu from any screen, tap the **Settings** button (). The main menu appears (shown below).

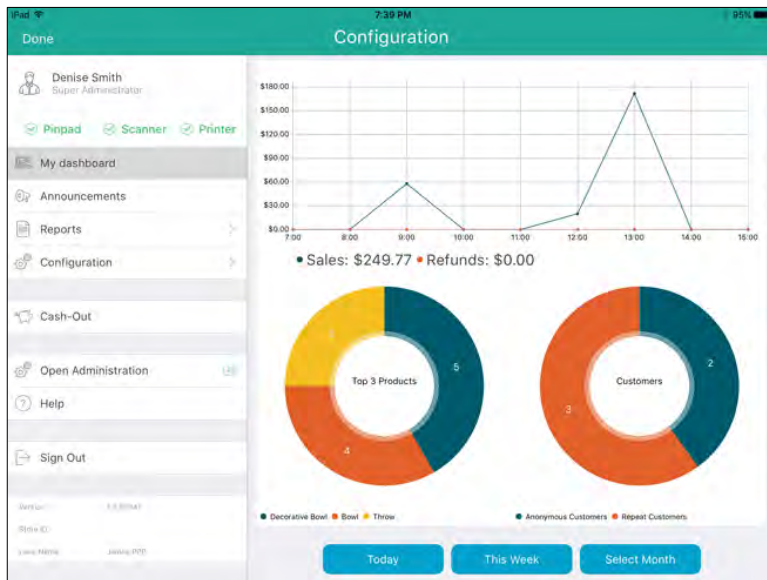

- To hide the main menu:
  - Tap **Done** in the top left corner of the screen.

### The panes

The PAYD Pro Plus App is generally divided into two panes (referred to in this guide as the “left pane” and the “right pane”). Menus and popups slide in from the left or right side of the screen, but generally the two panes remain visible (one pane becomes smaller depending upon which side of the screen displays a menu or popup).

### The on-screen keyboard and numberpad

The PAYD Pro Plus App makes use of the Apple iPad’s on-screen keyboard for data entry (i.e., customer or product names). Use this on-screen keyboard in the PAYD Pro Plus App just like you would in any other Apple iPad app. The PAYD Pro Plus App can use its own numberpad, or use the Apple iPad on-screen keyboard for numeric data entry too. When your data entry is finished, tap **OK** or **Return**, or the **Hide Keyboard** button

() to finalize your input. The keyboard is hidden again.

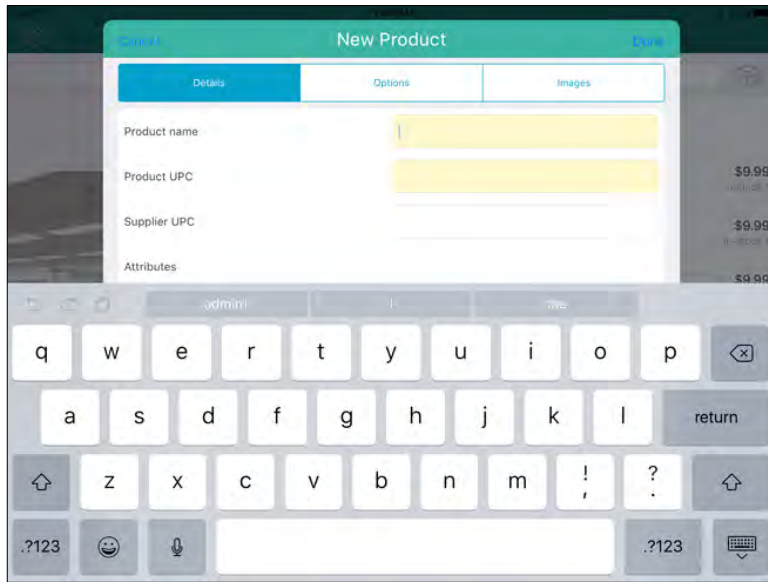

## Signing out

When you are finished using the PAYD Pro Plus App, follow the instructions below to sign out.

1. Tap the **Settings** button ().
2. On the main menu, tap **Sign Out**.  
A confirmation popup appears.
5. Tap **OK** to sign out.  
The Login screen appears.

## Cashing in

Use the Cash-In screen to count your opening till float (to account for the cash with which you are starting the business day). The screen will appear when you sign into the PAYD Pro Plus App after a cash-out has been processed (refer to [Cashing out](#) on page 120 for more information), or if you are logging into the PAYD Pro Plus App for the first time after downloading and installing the App. Follow the directions below to cash in your till.

**Note:** *If you do not see the Cash-In screen when you start the PAYD Pro Plus App, it means that the cash out process was not completed for the previous business day. Refer to [Cashing out](#) on page 120 for more information.*



### To cash in your till:

1. In the Cash-In screen, tap inside the various denomination fields (e.g., \$20, \$10, \$2 etc.) and enter the quantity of those denominations you have. For coins, if you have rolls of coins and loose coins, enter the quantity of rolls in the **Rolls** column on the right, and enter the loose change in the left column directly beside the denomination.

**Note:** You can use the **Next** button on the on-screen keyboard to quickly proceed to the next field e.g., if you tap inside the **\$20** field, then tap **Next**, the cursor will be placed in the **\$10** field.

2. Enter the amount of cheques into the **Cheque** field that your till is opening with (if applicable).
3. Tap **Continue** at the bottom of the screen.

The Sale screen appears.

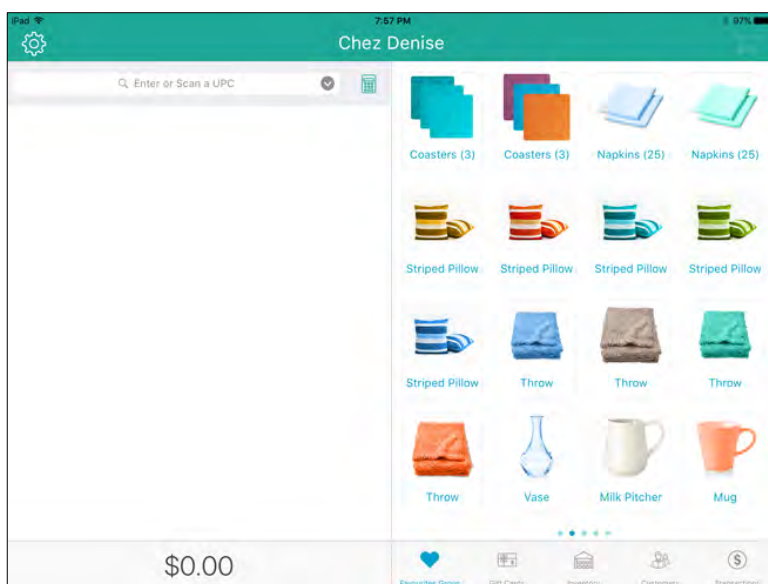

## Enroll in Merchant Direct®

Merchant Direct provides a variety of reporting options after your batch has been closed and your transactions have been settled. These reports include, but are not limited to:

- Monthly transaction reports
- Daily transaction reports
- Batch reports
- Chargeback reports
- Fees and deposits.

Additionally, if you have a question that contains sensitive information related to your business (such as transaction or financial inquiries), you can send us a secure message via Merchant Direct's Message Centre.

To sign up for Merchant Direct, follow these steps:

**Note:** *If you have already enrolled for Merchant Direct, you do not have to enroll again.*

1. Go to [moneris.com](https://moneris.com).
2. In the top right area of the screen, click **Login** and select **Merchant Direct**.
3. Click **Online Enrolment**.
4. Fill in the fields in the online form to complete your enrolment.



# Inventory management

You can use the Inventory screen to manage the business' inventory. Management functions include adding new products, editing product profiles, and deleting products.

## Adding new products

You can use the New Product popup to add products to the business' inventory.

**Note:** Based upon the PAYD Pro Plus software bundle and/or your Merchant Agreement with Moneris, you may encounter a limit to the number of product profiles that can be added to the product database. For more information on how to increase this limit, please call us at **1-855-423-PAYD (7293)** to upgrade today.

**Note:** Fields highlighted in yellow are mandatory.

1. On the Sale screen, tap **Inventory** at the bottom of the right pane.

2. Tap the **Add Product** button () at the top of the right pane.

The New Product popup appears.

3. Enter the product's name into the **Product name** field.

4. Tap inside the **Product UPC** field and use the Bluetooth® barcode scanner to scan the product's barcode.

OR

Tap inside the **Product UPC** field and use the on-screen keyboard to manually key in the digits from the product's barcode.

**Note:** If the product does not have a barcode, you may key in your own unique UPC code for this item.

5. Tap inside the **Supplier UPC** field and manually key in the supplier's UPC code for the product.

6. Use the on-screen numberpad to enter prices for the product:

- Tap inside the **Retail price** field and enter the item's retail price in dollars and cents. Tap the checkmark () when finished.

- Enter the item's list price in the **List price** field in dollars and cents. Tap the checkmark () when finished.

- Enter the item's unit cost (what you pay your supplier for the item) in dollars and cents into the **Cost price** field. Tap the checkmark () when finished.

7. In the **In-stock** field, enter the item's current on-hand value. Tap the checkmark () when finished.

8. If the item comes with a manufacturer's warranty, enter the item's warranty period in months into the

**Warranty period** field. Tap the checkmark () when finished. If the item does not come with a warranty, skip this step.

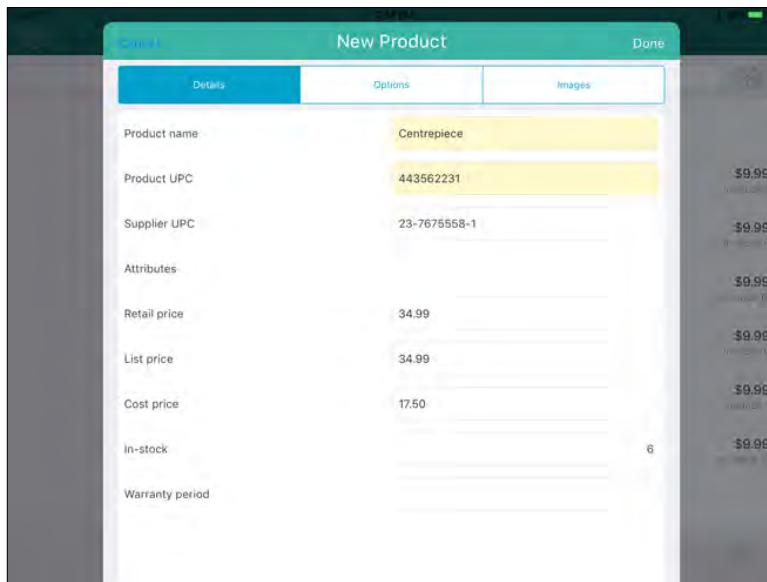

9. Tap the **Options** tab at the top of the New Product popup.
10. Select the taxes that are applicable to this product. If the product is tax exempt, tap **None**.
11. If you have brand names defined, use the **Brand name** selector to select the brand to which this item belongs and tap **Done** when finished. If you do not have brands defined, skip this step.
12. Set the product options following the guidelines below:
  - To make the product part of your inventory, toggle the **Track this products stock qty** switch to the right (Default = Enabled).
  - If you are recording this product's serial number at the time of purchase, toggle the **Prompt for serial number when sold** switch to the right (Default = Disabled).
  - If the product will require any type of service by your business, toggle the **This product requires service** switch to the right (Default = Disabled).
  - If a customer needs to be added to your customer database in order to purchase the product, toggle the **Registered customer required** switch to the right (Default = Disabled).
  - If the product is capable of being returned for a refund or exchange, toggle the **This product is returnable** switch to the right (Default = Disabled).
  - If the product you are selling is a gift card, toggle the **Is a gift card** switch to the right (Default = Disabled).
  - If an employee is able to earn commission when selling this product, toggle the **Use commission** switch to the right (Default = Disabled).
13. Do one of the following:
  - If you wish to include an image of the product in its profile, proceed to step 14.
  - If you do not wish to include an image, proceed to step 16.
14. Tap the **Images** tab at the top of the New Product popup.

15. If you wish to use the Apple iPad's camera to take a picture of the product, or use an image stored on the Apple iPad's internal memory, follow the steps below.

a. Tap the **box** icon () in the middle of the screen.

A popup appears.

b. Select the method by which you would like to add an image to the product profile:

- To use an image that is already stored on the Apple iPad's internal memory:

- i. Tap **Library**.

- Note:** If prompted to allow the PAYD Pro Plus App to access your Apple iPad's photo library, tap **Yes**.*

- ii. Browse the images stored on the Apple iPad, and tap the image once you locate it. Proceed to step 16.

- To take a picture of the product:

- i. Tap **Camera**.

- Note:** If prompted to allow the PAYD Pro Plus App to access your Apple iPad's camera, tap **Yes**.*

- ii. Take the photo.

- iii. Tap **Use Photo** to use the image. Proceed to step 16.

OR

Tap **Retake** to retake the image. Repeat step ii.

16. Tap **Done** in the top right corner of the New Product popup.

An Inventory screen appears in the right pane to provide you with the opportunity to edit the product profile.

17. Do one of the following:

- Edit the product profile; refer to [\*Editing products\*](#) on page 16 for more information.
- Tap **<Back** at the top of the right pane to save the product profile.

18. Repeat steps 2 – 17 to create other product profiles as necessary.



## Searching inventory

It is possible to search your inventory to locate products.

### Searching for a product

1. On the Sale screen, tap **Inventory** at the bottom of the right pane.
2. Tap inside the **Inventory Search** field at the top of the screen.
3. In the search text field, enter any of the following as your search criteria:
  - **Product ID** e.g., “12345678”
  - **Product Name** e.g., “Napkins (25)”
  - **Product Keywords** e.g., “napkins”
  - **Product Attributes** e.g., “Multi-coloured”
  - **Supplier’s UPC code** e.g., “0123456789000”

**Note:** You can enter all or part of the search criteria (e.g., “nap”).

4. Tap the **Search** key on the keyboard.

The search results appear in the right pane.

### Searching for all products

1. On the Sale screen, tap **Inventory** at the bottom of the right pane.
2. Tap inside the **Inventory Search** field at the top of the screen.
3. When the on-screen keyboard appears, tap the **Search** key.

The search results (every item entered in inventory) appear in the right pane listed by name in alphabetical order.

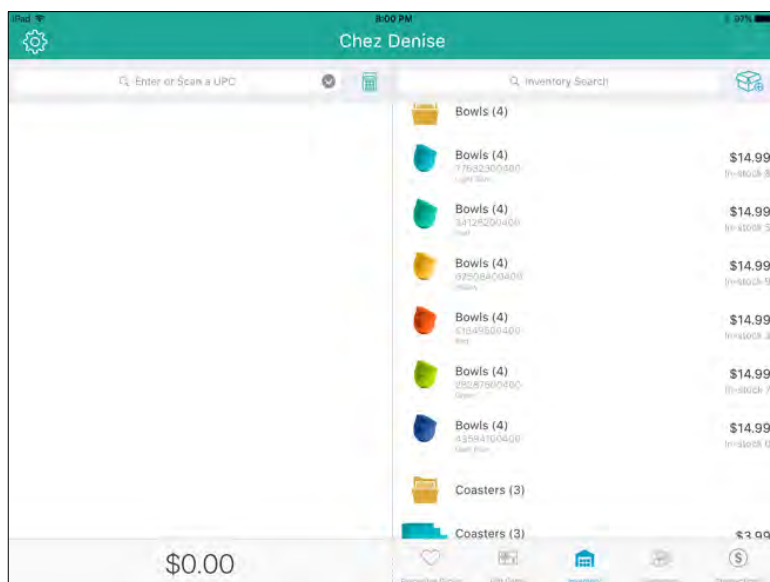

## Editing products

Once a product has been created and saved, you are able to edit its profile at any point.

1. On the Sale screen, tap **Inventory** at the bottom of the right pane.
2. Search for the product you wish to edit. Refer to [Searching inventory](#) on page 15 for more information.
3. Once you locate the product you wish to edit, slide the product from right to left to reveal the **More options** button (  ).

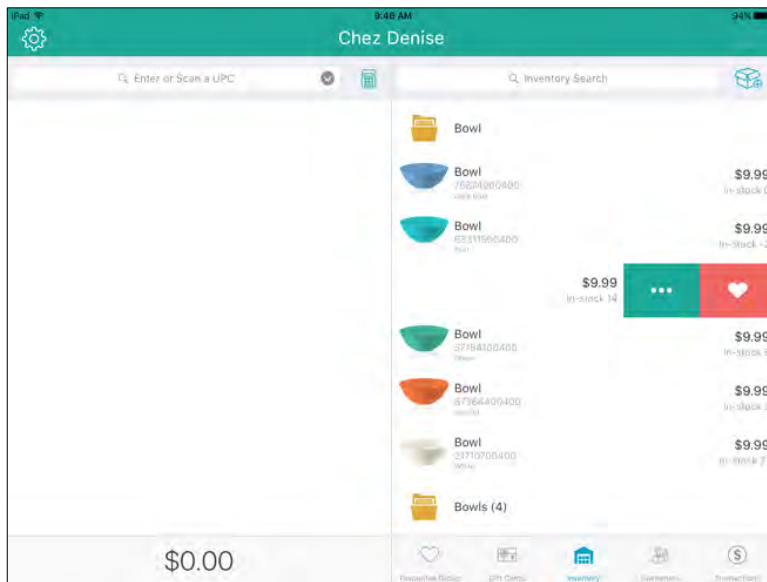

4. Tap the **More options** button.  
The right pane populates with the product's details.
5. Tap **Edit** at the top right corner of the right pane.

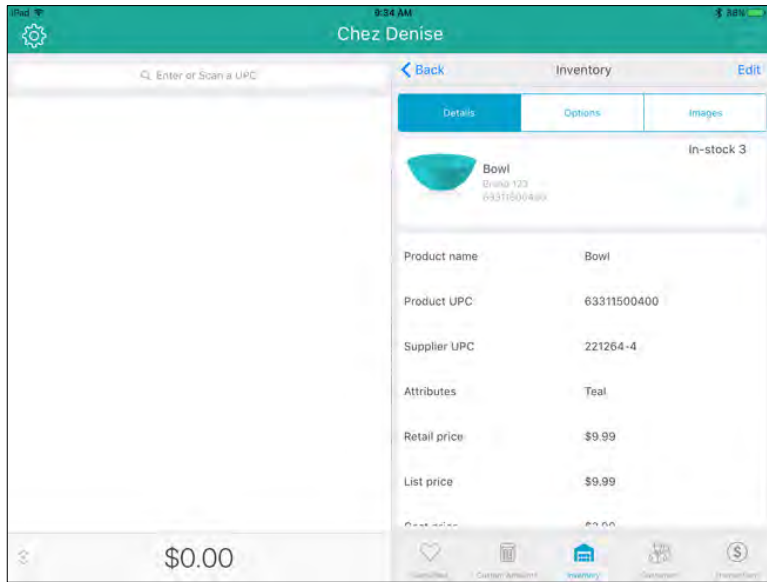



6. Make any changes as necessary.
7. Tap **Done** at the top of the right pane.
8. Tap **<Back** at the top of the right pane.
9. Repeat steps 2 – 8 to edit other products as necessary.

**Note:** Use PAYD Administration to capture even more information about products (e.g., Pricing Groups, Categories, and Attributes).

## Deleting products

It is possible to delete products that you no longer sell, or products that were created in error.

**Note:** *If a product profile is deleted, its information cannot be restored. If you want to re-add this product later on, its information will need to be re-entered.*

1. On the Sale screen, tap **Inventory** at the bottom of the right pane.
2. Search for the product you wish to edit. Refer to [Searching inventory](#) on page 15 for more information.
3. Once you locate the product you wish to delete, slide the product from right to left to reveal the **More options** button ().
4. Tap the **More options** button.  
The right pane populates with the product's details.
5. Tap **Edit** at the top right corner of the right pane.
6. Tap the **Delete** button ().  
A confirmation prompt appears.
7. Tap **Yes** to delete the product.  
The product list reappears.
8. Repeat steps 2 – 7 to delete additional products as necessary.



# Customer management

You can use the Customers screen to add, edit, and remove customers from the database.

## Adding new customers

Follow the instructions below to add a new customer profile to the database.

**Note:** Based upon the PAYD Pro Plus software bundle and/or your Merchant Agreement with Moneris, you may encounter a limit to the number of customer profiles that can be added to the customer database. For more information on how to increase this limit, please call us at **1-855-423-PAYD (7293)** to upgrade today.

**Note:** Fields highlighted in yellow are mandatory.

1. At the bottom of the Sale screen, tap **Customers**.

The Customer Search screen appears.

2. Tap the **Add New Customer** button () at the top of the right pane.

The New Customer popup appears.

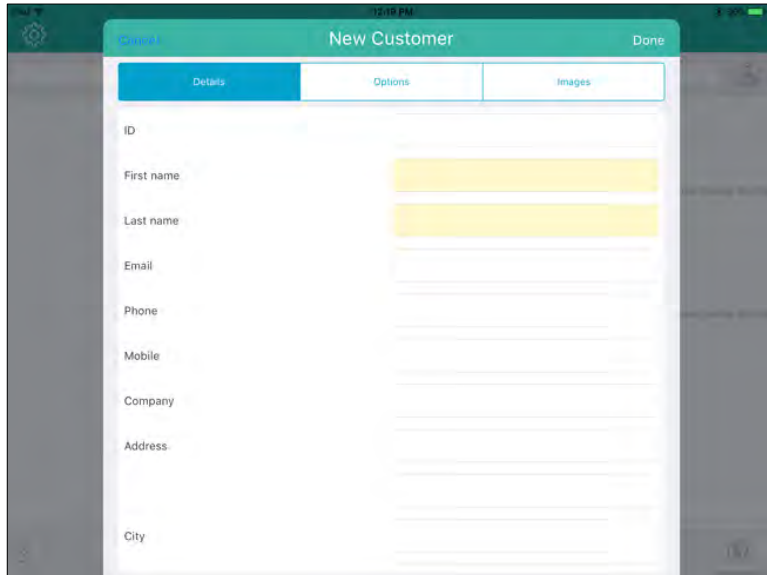

3. In the **Details** tab of the New Customer popup, fill out the fields following the guidelines below:

- **ID** – Leave this field blank for now. When the customer profile is saved, PAYD Pro Plus will automatically generate an ID for this customer.
- **First/Last name** – Enter the customer’s first and last name into these fields.
- **Email** – Enter the customer’s email address into this field.

**Note:** This is necessary if you will be emailing transaction receipts to this customer. The **Email a receipt copy** setting (on the **Options** tab) needs to be enabled as well.

- **Phone** – Enter the customer’s primary contact phone number into this field.

**Note:** Dashes or spaces are not necessary.

**Note:** A phone number or an email address (or both) are mandatory fields. However, the PAYD Pro Plus App will accept either just a phone number, or just an email address, without prompting that required fields are incomplete.

- **Mobile** – Enter the customer’s mobile or secondary contact phone number into this field if available.  
*Note: Dashes or spaces are not necessary.*  
*Note: A mobile phone number is necessary if you will be sending transaction receipts to this customer via SMS text. Refer to Generating SMS text receipts on page 85 for more information.*
  - **Company** – Enter the customer’s business name into this field.
  - **Address** – Enter the customer’s primary street address and unit number (if applicable) into this field.
  - **City** – Enter the customer’s city into this field.
  - **Postal code** – Enter the customer’s postal code into this field.
  - **Country** – Enter the customer’s country into this field.
  - **Province** – Enter the customer’s province into this field.
  - **Birthday** - Tap **Day** and use the date selector to select the *birthday*, then tap **Done** when complete. Tap **Month** and use the date selector to select the *month*, then tap **Done** when complete.
  - **Notes** – Tap inside the field and use the on-screen keyboard to enter any notes regarding this customer.
4. Tap the **Options** tab at the top of the New Customer popup.
5. Fill out the customer options as follows:
- **Language** – Tap **Select**, and use the language selector to choose the customer’s default language (for receipts and correspondence), then tap **Done**. By default, the merchant’s default language will be selected.
  - **Pricing group** – Tap **None**, and use the pricing group selector to choose the pricing group to which this client belongs (if applicable), then tap **Done**. By default, the customer does not belong to a pricing group until assigned.
  - **Email a receipt copy** – Toggle this switch to the right (Enabled) to allow this client to receive emailed copies of their transaction receipts.  
*Note: You must enter an email address in the **Email** field (on the **Details** tab).*
  - **Part of mailing list** – Toggle this switch to the right (Enabled) to allow this client to receive promotional emails from your business.
  - **Taxes** – Tap the tax that this client is required to pay for purchases. By default the customer will be paying all taxes. If the client has tax exempt status, tap **None**.
  - **Tax exemption registration** – If this client is eligible for tax exemptions in your jurisdiction, enter their registration number in this field. If the customer does not have tax-exempt status, leave this field blank.
  - **Band number** – If this customer has a native status card, enter their band number from the card into this field. If the customer does not have a native status card, leave this field blank.
6. (Optional) Tap the **Images** tab at the top of the New Customer popup. If you do not want to include a customer picture, proceed to step 8.
7. Add a picture of the customer following the steps below:
- a. Tap **Select** in the middle of the Images tab.  
A popup appears.
  - b. Select the method by which you would like to add an image to the customer profile:
    - To use an image that is already stored on the Apple iPad’s internal memory:

- i. Tap **Library**.

**Note:** *If prompted to allow the PAYD Pro Plus App to access your Apple iPad's photo library, tap **Yes**.*

- ii. Browse the images stored on the Apple iPad, and tap the image once you locate it. Proceed to step 8.

- To take a picture of the customer:

- i. Tap **Camera**.

**Note:** *If prompted to allow the PAYD Pro Plus App to access your Apple iPad's camera, tap **Yes**.*

- ii. Take the photo.

- iii. Tap **Use Photo** to use the image. Proceed to step 8.

OR

Tap **Retake** to retake the image. Repeat step ii.

8. Tap **Done** in the top right corner of the New Customer popup.
9. Repeat steps 2 – 8 to add other customers as necessary.



## Searching customers

It is possible to search your database for customers that have been added.

### Searching for a customer

1. At the bottom of the Sale screen, tap **Customers**.

The Customer Search screen appears.

2. Tap inside the **Customer Search** field at the top of the right pane and use the on-screen keyboard to enter any of the following as your search criteria:
  - **Customer ID** e.g., "JSMI001"
  - **Customer name** e.g., "John Smith"
  - **Customer phone number** e.g., "555-555-5555"
  - **Customer email address** e.g., "[john.smith@johnsmithemail.com](mailto:john.smith@johnsmithemail.com)"

***Note:** You can enter all or part of the search criteria (e.g., "john").*

3. Tap the **Search** key.

The search results appear below.

### Searching all customers

1. At the bottom of the Sale screen, tap **Customers**.

The Customer Search screen appears.

2. Tap inside the **Customer Search** field at the top of the right pane.
3. When the on-screen keyboard appears, tap the **Search** key.

The search results (all customers defined in the customer database) appear below, listed alphabetically by first name.

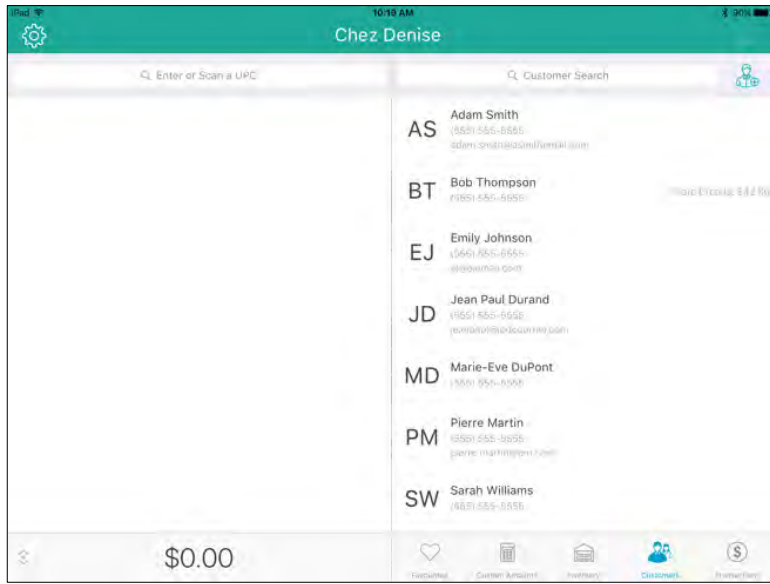

## Editing a customer profile

It is possible to edit a customer's profile after it has been saved.

1. At the bottom of the Sale screen, tap **Customers**.

The Customer Search screen appears.

2. In the Customers screen, search for the customer you wish to edit. For more information, refer to [Searching customers](#) on page 23.

3. Once you locate the customer, slide their name from right to left to reveal the **More options** button ().

4. Tap the **More options** button.

The customer's profile loads into the right pane.

5. Tap **Edit** at the top of the right pane.

6. Edit the customer's profile as necessary. For an explanation of the various fields, refer to step 4 of the [Adding new customers](#) section on page 20.

7. Once you have finished making changes, tap **Done** at the top of the right pane to save your work.

8. Repeat steps 2 – 7 to edit other customer profiles as necessary.

## Deleting customers

It is possible to delete customers who no longer patronize your business, or whose profiles were created in error.

**Note:** *If a customer profile is deleted, their information cannot be restored. If you want to re-add this customer later on, the information will need to be re-entered.*

1. At the bottom of the Sale screen, tap **Customers**.

The Customer Search screen appears.

2. In the Customers screen, search for the customer you wish to delete. For more information, refer to [Searching customers](#) section on page 23.

3. Once you locate the customer, slide their name from right to left to reveal the **More options** button (.

4. Tap the **More options** button.

The customer's profile loads into the right pane.

5. Tap **Edit** at the top of the right pane.

6. Tap the **Delete** button (.

A confirmation prompt appears.

7. Tap **Yes** to delete the customer.

The customer list reappears.

8. Repeat steps 2 – 7 to delete other customers as necessary.



# The Favourites Group



The Favourites Group is a configurable display of items that occupies the right pane in the Sale screen. The Favourites Group provides quick access to your most frequently used inventory or to your most frequent customers, so you can add them quickly to a sale by a simple tap (rather than having to search for it).

## Adding products to the Favourites Group

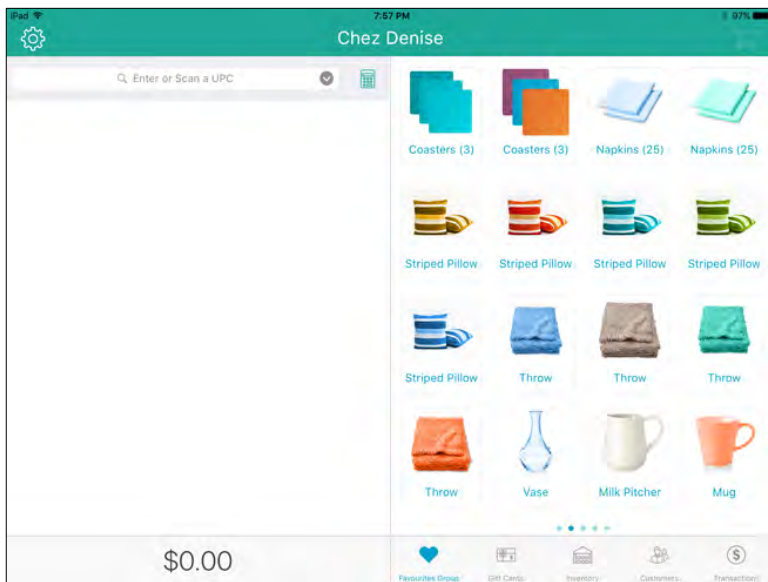
The Favourites Group is split into 5 tabs. Each tab is capable of holding up to 16 products, so you can add a maximum of 80 products to the Favourites Group.



### To add products to the Favourites Group from the Sale screen:

1. Tap the **Favourites Group** button () at the bottom of the Sale screen.
2. Tap and hold a blank area of the screen. A grid with 16 rectangles appears.
3. Tap one of the blank rectangles with the **Add Item** icon ()

The left pane populates with Inventory Search functionality.

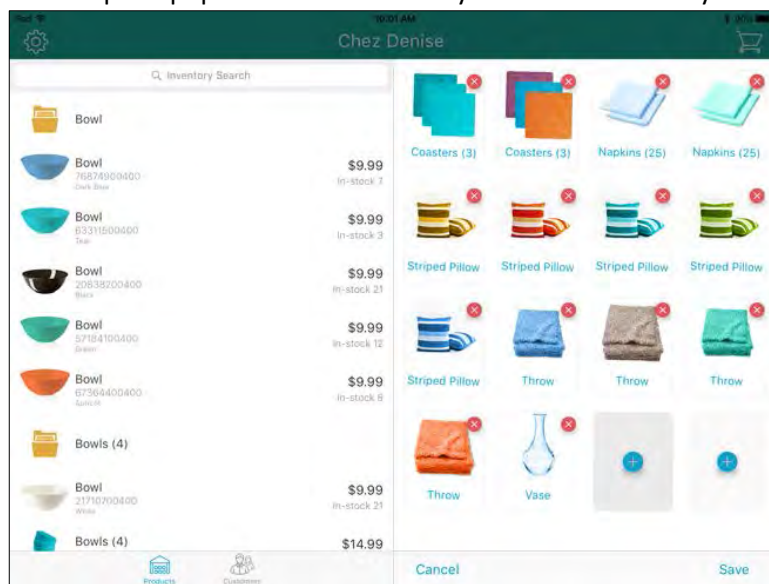

4. To add items to this tab in the Favourites Group, do one of the following:
  - **Search:**
    - a. Tap inside the **Inventory Search** field at the top of the left pane.
    - b. Use the on-screen keyboard to enter the product's **ID** (barcode), **name**, **keywords**, **attributes**, or the **supplier UPC** into the field.
    - c. Tap the **Search** key on the keyboard.
    - d. When the item appears in the search results on the left pane, tap it to add it to the Favourites Group on the right pane.
    - e. Proceed to step 5.
  - **Scan:**
    - a. Tap inside the **Inventory Search** field at the top of the popup.
    - b. Scan the product's barcode with the Bluetooth scanner.  
The product appears in the search results below.
    - c. When the item appears in the search results on the left pane, tap it to add it to the Favourites Group on the right pane.
    - d. Proceed to step 5.
5. Repeat step 4 to add other products as necessary.
6. Tap **Save** at the bottom of the right pane.

#### To add products to the Favourites Group from the Inventory screen:

1. On the Sale screen, tap **Inventory** at the bottom of the right pane.
2. Search for the product you wish to edit. Refer to [\*Searching inventory\*](#) on page 15 for more information.
3. Once you locate the product you wish to add to Favourites, slide the product from right to left to reveal the **Add to Favourites** button ().
4. Tap the **Add to Favourites** button.  
The operation is processed and the product is added to the Favourites Group.
5. Repeat steps 2 – 4 to add other products as necessary.

# Removing products from the Favourites Group

Follow the steps below to remove products from the Favourites Group.

**Note:** Removing products from the group does not remove them from the inventory database.

1. Tap the **Favourites Group** button (  ) at the bottom of the Sale screen.
2. Navigate to the tab that contains the item you wish to remove.
3. Tap and hold on the item you wish to remove.

The products on that tab begin to wiggle and a red X appears in the top right corner of each product tile.

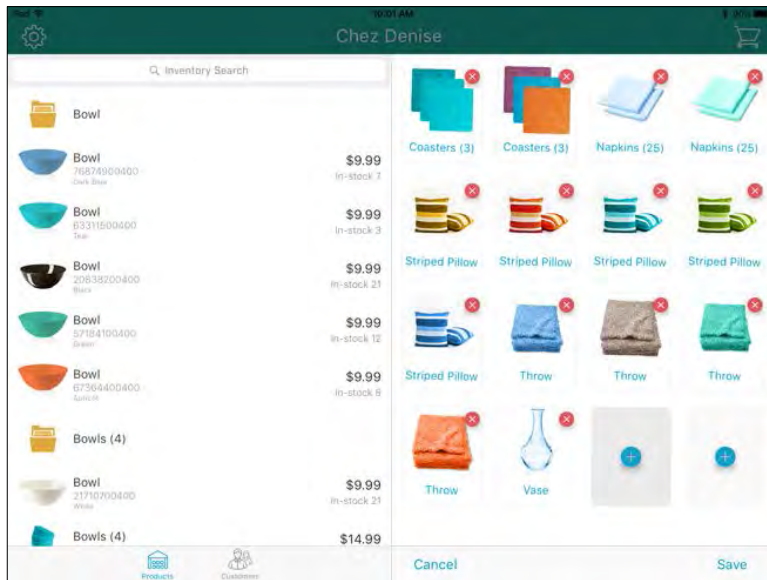

4. Tap the red X.  
The product is removed from the Favourites Group.
5. Tap **Save** in the bottom right corner of the right pane.
6. Repeat steps 1 – 5 to remove other products as necessary.



## Adding a customer to the Favourites Group

It is possible to add customers to the Favourites Group that appears in the Sale screen.

1. At the bottom of the Sale screen, tap **Favourites**.
2. Select the favourites tab at the bottom of the right pane to which you want to add the customer.
3. Tap and hold a blank area of the right pane.

On the right pane, a grid with 16 rectangles will appear. The left pane populates with the Product Search screen.

4. Tap **Customers** at the bottom of the left pane.

The Customer Search screen appears.

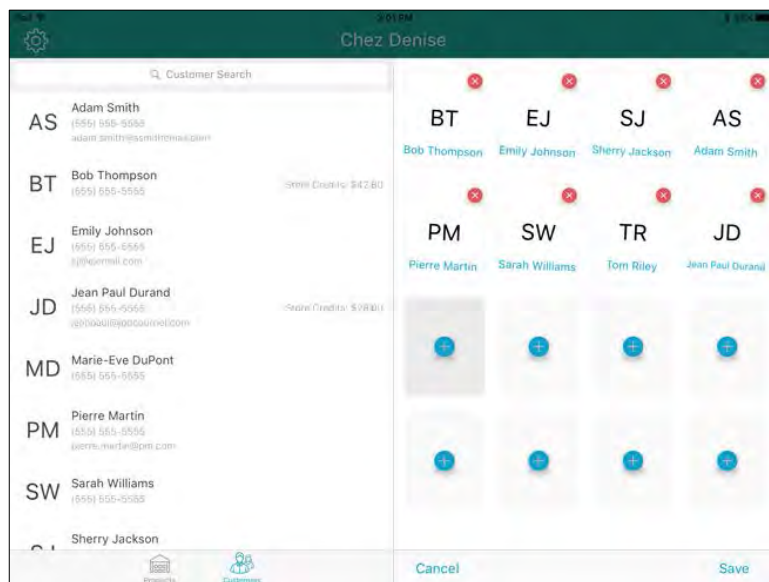

5. Tap the **Customer Search** field at the top of the left pane.
6. Use the on-screen keyboard to enter the customer's ID, name, phone number, or email into the search field.

The system searches the customer database and search results appear below.

**Hint:** By default, the entire customer list appears and you can scroll through to select a customer.

7. Tap a customer's name in the search results.  
They are added to the Favourites Group.
8. Repeat steps 5 - 7 as necessary to add other customers to the tab.
9. Tap **Save** at the bottom of the right pane.

## Editing the contents of the Favourites Group

Take the following steps if you are replacing older items in the Favourite Groups, or if an item has been added to the wrong tab:

1. Remove items from the group that are no longer needed. Follow the instructions on *Removing products from the Favourites Group* on page 30.
2. Add items to the group. Follow the instructions on *Adding products to the Favourites Group* on page 28.
3. You can also reposition items in the Favourites Group by tapping and holding down on the item you wish to move, until the item starts wiggling. Then you can drag-and-drop it to another spot within the tab.



# Processing transactions

This section explains how to process transactions in the PAYD Pro Plus App.

## Before you get started

This section explains how to perform the following tasks:

- Starting a sale
- Assigning a customer to a sale
- Adding products to a sale
- Manipulating quantities and prices
- Applying discounts
- The Custom Amounts function
- Suspending and resuming transactions
- Cancelling transactions
- Processing payments:
  - cash
  - cheque
  - entering payment cards
  - debit cards
  - credit cards
  - store credit
  - Moneris Gift Cards
  - split tender
- Processing layaway transactions
- Producing and sending invoices
- Receipt options
- Optional POS devices
  - e355 PIN Pad
  - iPP320 PIN Pad
  - PAYD PIN Pad
  - Bluetooth barcode scanner
  - Bluetooth receipt printer and cash drawer
- Customer prompts on the PIN Pads

Please note the following information before you begin processing transactions:

- Integrated versus non-integrated merchants:
  - All **integrated merchants** have their *Interac*® Debit and credit payments processed by Moneris, and are able to use the Moneris PAYD PIN Pad, the Moneris e355 PIN PAD, or the iPP320 PIN Pad to accept credit and *Interac* Debit payments from their customers. Integrated merchants can also process Moneris Gift Cards with a Moneris PIN Pad.

- **Non-integrated merchants** do not use Moneris' *Interac* Debit and credit processing. They will need to process debit and credit cards outside of the PAYD Pro Plus App. Non-integrated merchants will be unable to process Moneris Gift Cards.
- **Shopping cart of items** – This term refers to the left pane of the Sale screen where the customer's items for purchase are displayed.
- **Continue the sale** – This instruction refers to adding products to the shopping cart of items, manipulating quantities and prices, and applying discounts.
- **Complete the transaction** – This instruction refers to selecting a payment method, processing the payment method, and finally processing receipts.
- **Receipts** - The PAYD Pro Plus App has the ability to **print paper receipts** from a Bluetooth receipt printer, send a receipt via **SMS text message**, and the ability to **email** a receipt copy to a customer. It is also possible to print **gift receipts** if configured. For the purposes of this guide, the term “process receipts” at the end of instructions refers to these output types. You can select your receipt output type in the Configuration – Receipts screen. To learn more about configuring your receipts and the output type, refer to the **PAYD Pro Plus® Mobile Solution: Configuration Guide** available at [moneris.com/support-PAYDProPlus-mobile](http://moneris.com/support-PAYDProPlus-mobile).

## General guidelines for performing a transaction

Generally speaking, purchase transactions occur in the following sequence:

1. Start on the Sale screen.
2. If applicable, assign a customer.
3. Select the product(s) the customer is buying.
4. If applicable, edit the prices and/or quantities and/or apply discounts.
5. Process payment.
6. Send or print receipt(s).

All the instructions pertaining to processing sale transactions in this guide make the assumption that you have started the sale.

# Processing sales

## Processing a sale without assigning a customer

It is possible to process a sale without assigning a customer. Simply start the sale and add products to the bill. Proceed to the [Adding products to a sale](#) section on page 37 for instructions.

## Assigning a customer to a sale

There are three methods for assigning a customer to a sale:

- Search
- Create new
- Tap to add from the Favourites Group

## Searching for customers

Follow the instructions below to search for a customer to add to the sale.

1. In the Sale screen, tap **Customers** at the bottom of the right pane.

The Customer Search screen appears.

2. Search for a specific customer.

OR

Search your entire list of customers. Refer to [Searching customers](#) on page 23 for more information on how to search your customer database.

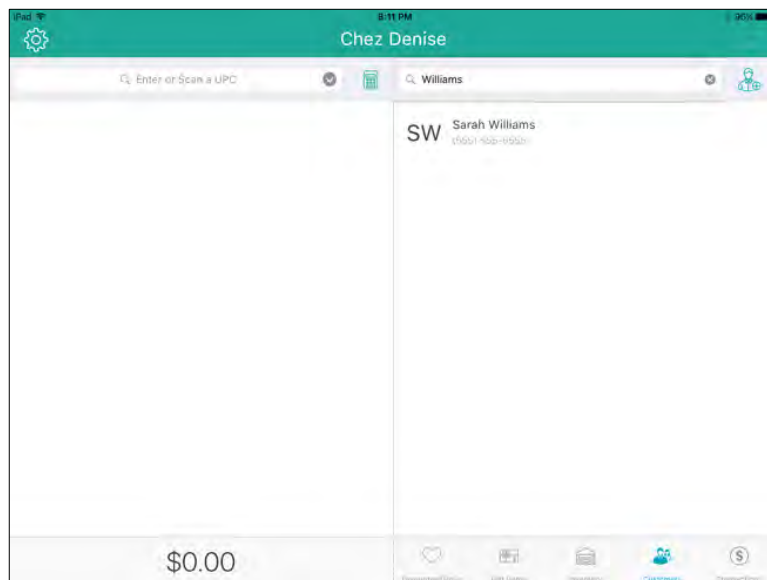

3. Once you locate the customer in the search results, tap their name.  
The customer's name appears in the totals bar at the bottom of the left pane.
4. Continue the sale.

## Creating a new customer profile

Follow the instructions below to create a profile for the customer and attach them to the sale.

**Note:** Based upon the PAYD Pro Plus software bundle and/or your Merchant Agreement with Moneris, you may encounter a limit to the number of customer profiles that can be added to the customer database. For more information on how to increase this limit, please call us at **1-855-423-PAYD (7293)** to upgrade today.

1. In the Sale screen, tap **Customers** at the bottom of the right pane.
2. Tap the **New Customer** button () at the top of the right pane.  
The New Customer popup appears.
3. Create a profile for the new customer. For more information, refer to the [Adding new customers](#) section on page 20.  
The customer is added to your database.
4. Search for the new customer. Refer to [Searching customers](#) on page 23 for more information on how to search.
5. Tap the customer's name.  
The customer's name appears at the bottom of the left pane.
6. Continue the sale.

## Adding a customer from the Favourites Group

1. In the Sale screen, tap the tab in your Favourites Group that contains your customers.
2. Tap the customer's name.  
The customer's name appears at the bottom of the left pane.
3. Continue the sale.

## Adding products to a sale

There are 3 methods of adding products to a sale:

- Scan
- Search
- Tap to add from the Favourites Group

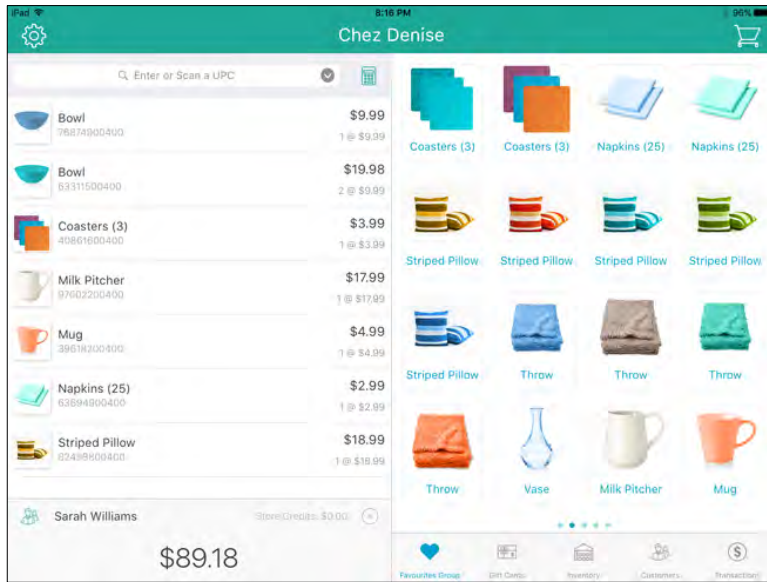

## Scanning products

1. In the Sale screen, tap the **Enter or Scan a UPC** field at the top of the left pane.
2. Scan the product's barcode.  
The product is added to the shopping cart of items.
3. Repeat steps 1 and 2 to scan additional products to add to the bill.
4. Complete the transaction.

**Note:** If the message "Product ID not found in inventory" appears, the barcode you scanned is not associated with the product. Tap **OK** and cancel the sale (refer to [Cancelling transactions](#) on page 50 for more information). Edit the product to associate the barcode with the item. Refer to [Editing products](#) on page 16 for more information.

## Searching for products

1. In the Sale screen, tap the **Enter or Scan a UPC** field at the top of the left pane.
2. In the search field, enter the product's UPC code (product ID) as your search criteria.  
The product is added to the sale.
3. Repeat steps 1 and 2 to search for additional products as needed.
4. Complete the transaction.

## Adding products from the Favourites Group

If the Favourites Group is enabled, and populated with products, follow the instructions below.

1. In the Sale screen, tap **Favourites** at the bottom of the right pane.
2. Tap the tab at the bottom of the Favourite Groups that contains the customer's desired item.



3. Tap the product's name/image.

The product is added to the shopping cart of items.

5. Repeat step 3 for any other products in the current tab.
6. Repeat steps 2 – 4 for products that reside on other tabs in the Favourites Group.
7. Complete the transaction.

## Adding non-inventory items to a sale

It is possible to add a product that is not yet in your inventory database to a sale.

**Note:** Based upon the PAYD Pro Plus software bundle and/or your Merchant Agreement with Moneris, you may encounter a limit to the number of product profiles that can be added to the product database. For more information on how to increase this limit, please visit us at [moneris.com/paydproplus](http://moneris.com/paydproplus) or call us at **1-855-423-PAYD (7293)** to upgrade today.

1. In the Sale screen, tap **Inventory** at the bottom of the right pane.
2. Tap the **Add Product** button (  ) at the top of the right pane.  
The New Product popup appears.
3. Follow the instructions in the [Adding new products](#) section on page 12 (starting at step 3) to capture the rest of the product's information.

## Editing quantities and prices

Once products are on the bill, it is possible to edit the quantity of items being sold, as well as the product's price.

### Adjusting item quantity

There are two ways to adjust a product's quantity once it is on the bill: scanning the item again or tapping the quantity adjustment buttons.

#### Scanning

- To adjust the quantity of an item by scanning, simply scan the item's barcode multiple times as necessary. The quantity indicator to the right of the product's name on the bill will increase each time the item is scanned e.g., "3 @ \$14.99".

#### Using the quantity adjustment buttons

1. Tap the product's name on the shopping cart of items.  
Product details appear on the right pane.

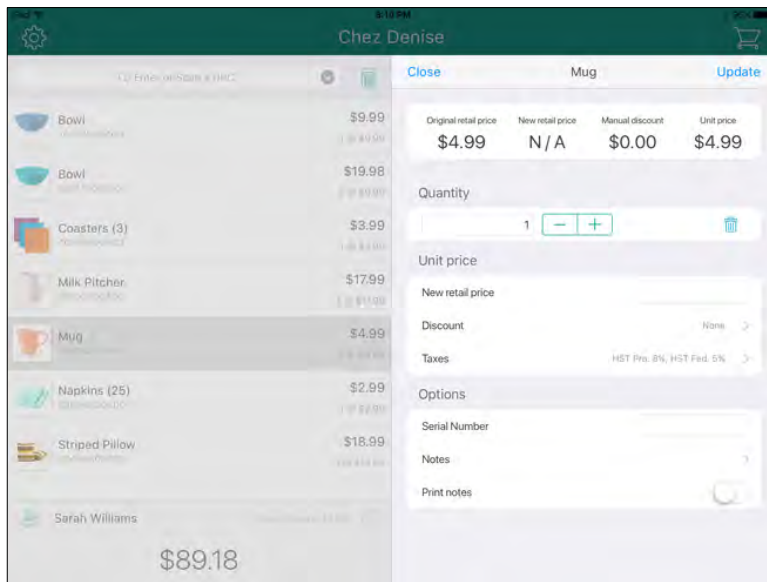

2. Change the quantity:
  - To increase the item quantity, tap the + button.

OR

  - To decrease the item quantity, tap the – button.
3. Tap **Update** at the top of the popup to close it.  
The item’s quantity is adjusted.
4. Repeat steps 1 – 3 to adjust other item quantities as needed.
5. Complete the transaction.

## Adjusting product price

Adjusting a product’s price on the bill affects only the transaction on which the price is being changed. It does not affect the product’s price outside the current transaction. Follow the instructions below to change the retail price of a product for one transaction only.

**Note:** *If you wish to change the item’s overall price (applicable for any transaction), refer to the [Editing products](#) section on page 16.*

1. Tap the product’s name on the shopping cart of items.  
Product details appear on the right pane.
2. Tap inside the **New retail price** field and use the on-screen numberpad to enter a new price in dollars and cents. Tap the checkmark (  ) when finished.
3. Tap **Update** at the top of the popup.  
The item’s price is adjusted.
4. Repeat steps 1 – 3 to adjust other item prices as needed.

5. Complete the transaction.

## Removing products from the shopping cart of items

If a product has been added to the shopping cart of items by mistake, or if the customer changes their mind about something before paying, follow the instructions below to remove the product(s).

1. Locate the product's name on the shopping cart of items.
2. Slide the product's name from right to left to reveal the **Remove** button.

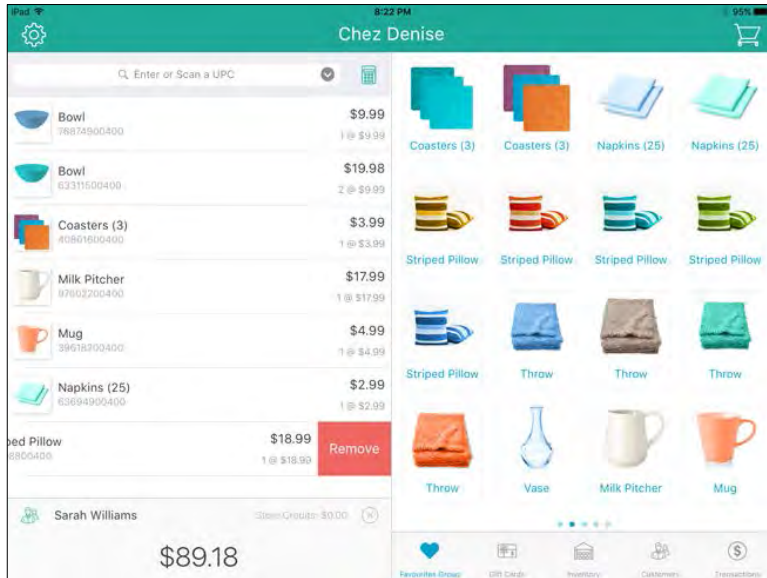

3. Tap the **Remove** button.  
The product is removed from the shopping cart of items.
4. Repeat steps 1 - 3 as necessary to remove other products from the bill.
5. Complete the transaction.

## Applying discounts

Discounts can be applied to products once they have been added to the bill. It is also possible to apply a discount to the overall transaction.

### To apply discounts to specific items on the bill:

1. Tap the product's name on the bill.  
The product details appear on the right pane.
2. In the right pane, tap the **Discount** line.  
The Discount screen appears.

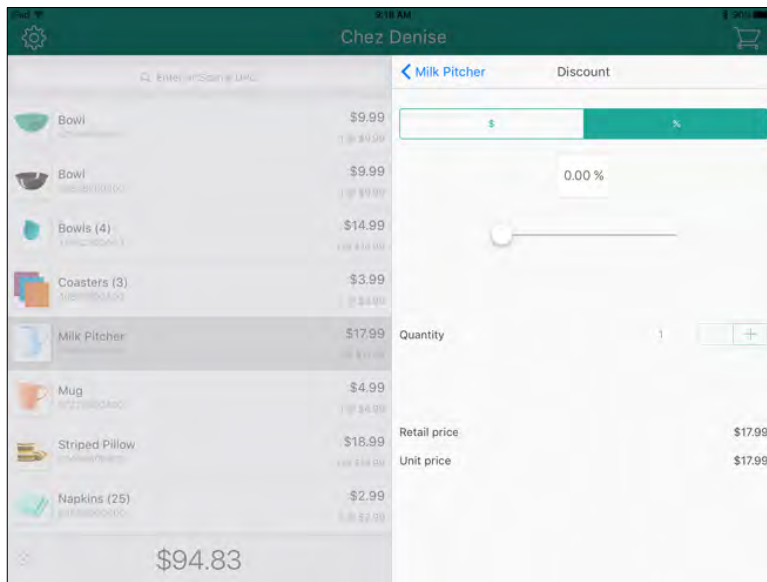

3. In the Discount screen, take the following action:

- **To apply a percent discount:**

- a. Tap the % button (ensure it is coloured teal).
- b. Use the horizontal slider to select the discount amount. Sliding to the right increases the amount; sliding to the left decreases the amount.

OR

Tap inside the % field and use the numeric keypad to enter a percentage. Tap the checkmark (  ) when finished.

- c. Select whether you want the discount applied to individual items or all items. For example, if 5 of the same item are being sold, will the discount apply to all 5 items, or only to 3 of 5?
  - To apply the discount to a limited number of items, tap the + button beside the **Quantity** field.

OR

- To apply the discount to the total quantity of that one product, do not change the value in the **Quantity** field.

d. Proceed to step 4.

- **To apply a dollar discount:**

- a. Tap the \$ button (ensure it is coloured teal).

- b. Use the horizontal slider to select the discount amount. Sliding to the right increases the amount; sliding to the left decreases the amount.

OR

Tap inside the \$ field and use the numeric keypad to enter a dollar amount. Tap the checkmark



() when finished.

- c. Select whether you want the discount applied to individual items or all items. For example, if 5 of the same item are being sold, will the discount apply to all 5 items, or only to 3 of 5?
  - To apply the discount only to limited number of items, tap the + button beside the **Quantity** field.

OR

- To apply the discount to the total quantity of that one product, do not change the value in the **Quantity** field.

- d. Proceed to step 4.

4. Tap the product name link at the top of the Discount screen.
5. Tap **Update** at the top of the right pane to close it.

The discount is applied to the item.

6. Repeat steps 1 – 5 to discount other items on the bill as necessary.
7. Complete the transaction.

#### **To apply a discount to the entire transaction:**

1. Tap the total amount at the bottom of the left pane.

A popup slides up from the bottom.
2. Swipe right to reveal the Sale Discount section.

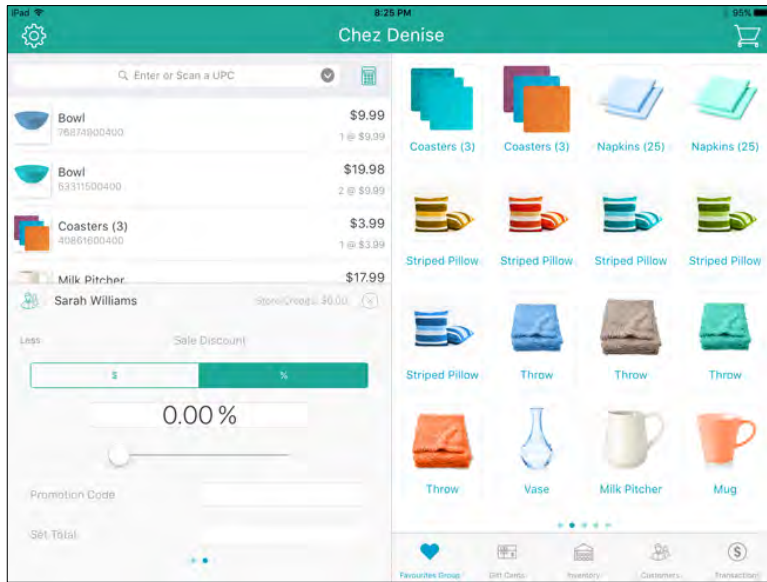

3. Choose the following discount type:

- **To apply a percent discount:**

- a. Tap the % button (ensure it is coloured teal).
- b. Tap inside the % field and use the numeric keypad to enter a percentage. Tap the checkmark (  ) when finished.

OR

Key in a percentage amount in the field (located below the \$ and % buttons). Tap the checkmark (  ) when finished.

- c. Proceed to step 4.

- **To apply a dollar discount:**

- a. Tap the \$ button (ensure it is coloured teal).
- b. Use the horizontal slider to select the discount amount. Sliding to the right increases the amount; sliding to the left decreases the amount.

OR

Key in a dollar amount in the field (located below the \$ and % buttons). Tap the checkmark (  ) when finished.

- c. Proceed to step 4.

- **To apply a defined discount code:**

- a. Tap inside the **Promotion Code** field and enter the discount code.

**Note:** Promotion codes are defined and managed using PAYD Administration. Click the **Help** () button in PAYD Administration for more help on creating promotion codes.

- b. Proceed to step 4.
4. Complete the transaction.

## The Custom Amounts function

The Custom Amounts function enables PAYD Pro Plus Mobile merchants to process transactions that include non-inventory products even more rapidly. Instead of adding the product profile to the sale, simply enter the price you are charging for the product using the Custom Amounts numeric keypad.

**Note:** The Custom Amounts function simply provides merchants with the ability to quickly add a non-inventory product to the sale. This function does not add the item to inventory; therefore the product sales are not tracked.

The Custom Amounts function is enabled by default in the Configuration – Interface screen. It appears as a

button () at the top of the left pane.

## Using the Custom Amounts function

Follow the instructions below to use the Custom Amounts function.

**Important:** Do not use the Custom Amounts function for products that are already defined in inventory. Add those products to the sale following the instructions in the [Adding products to a sale](#) section on pages 37 and 38. Use this function **ONLY** when selling items that are not yet defined in inventory.

### To use the Custom Amounts function:

1. At any point during a sale, tap the **Custom Amounts** button () at the top of the left pane.

The numeric keypad appears in place of the Favourites Group.

2. Use the numeric keypad to enter a price for the product.

3. Tap the checkmark () to add the product to the sale.

The non-inventory product is added to the transaction.

4. Repeat steps 2 and 3 for additional non-inventory products being added to this sale.

**Note:** You can add multiple non-inventory products to any sale. You can also adjust their quantity or prices, and apply discounts just like you would with any other product.

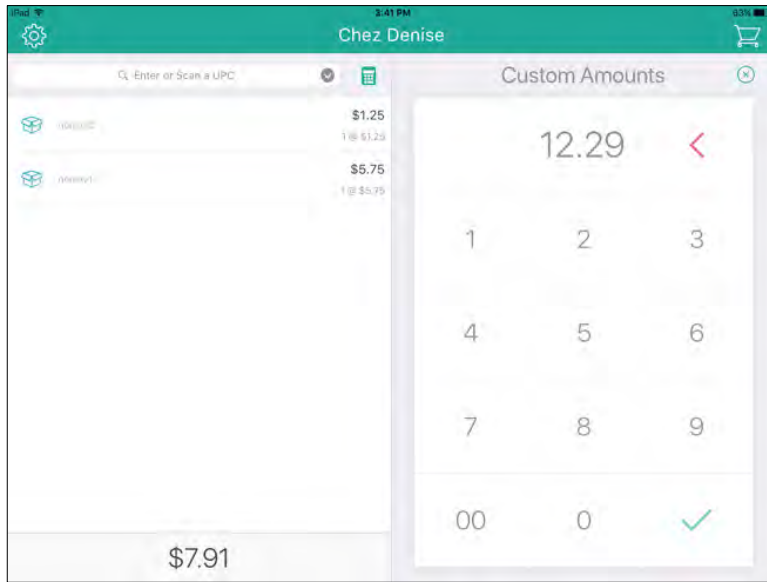

5. When finished, close the Custom Amounts numeric keypad by tapping the **X** symbol at the top of the right pane.  
The keypad disappears and the Favourites Group becomes visible once more.
6. Complete the transaction.



## Suspending and resuming transactions

Once a sale transaction has been started, it is possible to suspend it. When the customer is ready to pay, their suspended transaction can be resumed. Transactions can be suspended and resumed as often as needed.

**Note:** It is also possible to suspend a Return transaction before payment is processed. The steps presented here are applicable to both Sales and Returns.

**Note:** It is possible to suspend a transaction in the PAYD Pro Plus App and resume it in the POS view of the PAYD Pro Plus In-Store Solution, and vice-versa.

### Suspending a transaction

A transaction can be suspended up to any point before payment is ready to be processed. Suspending a transaction preserves all of its details (e.g., customer, products, prices, discounts). Follow the instructions below to suspend a transaction.

1. If applicable, assign a customer to the sale.
2. Add product(s) to the sale.
3. Adjust quantities and/or prices and apply discounts as necessary.
4. Tap the total at the bottom of the left pane.

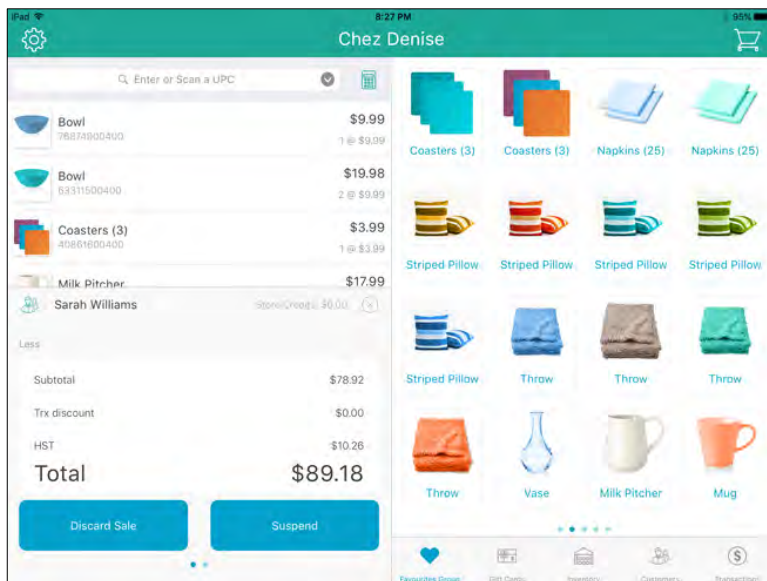

5. In the popup, tap the **Suspend** button.  
A prompt appears asking if you want to suspend the sale.
6. Tap **Yes**.  
The transaction is suspended and a blank Sale screen appears, ready to take the next transaction.

## Resuming suspended transactions

Follow the instructions below to resume suspended transactions.

1. Tap **Transactions** at the bottom of the right pane.
2. In the top right corner of the Transaction Search screen, tap **All Status**.  
The Select Status popup appears.
3. In the Select Status popup, scroll to select **Suspended**.
4. Tap **Done**.  
The Transaction Search screen displays a list of currently suspended transactions.
5. Scroll through the list to locate the transaction you wish to resume (the transactions appear with the date & time stamp of when the transaction was suspended, along with the customer's name and the transaction's projected expiry date).
6. On the right pane, slide the transaction from right to left (revealing **Resume** and **Discard** buttons).

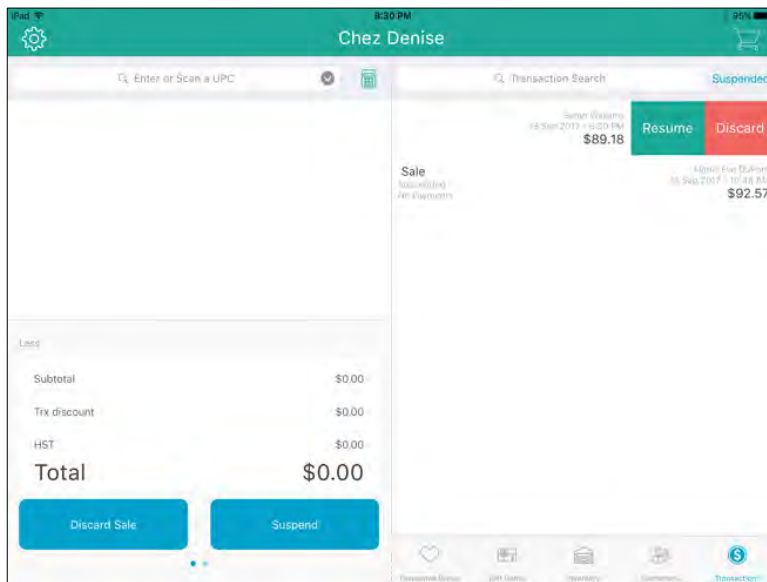

7. Tap the **Resume** button.  
The populated Sale screen appears.
8. Complete the transaction as necessary.

## Discarding suspended transactions

If a suspended transaction needs to be eliminated without needing to process payment, follow the instructions below.

1. Tap **Transactions** at the bottom of the right pane.
2. In the top right corner of the Transaction Search screen, tap **All Status**.

3. In the Select Status selector, scroll to select **Suspended**.
4. Tap **Done**.  
The Transaction Search screen displays a list of currently suspended transactions.
5. Scroll through the list to locate the transaction you wish to resume (the transactions appear with the date & time stamp of when the transaction was suspended, along with the customer's name and the transaction's projected expiry date).
6. On the right pane, slide the transaction from right to left (revealing **Resume** and **Discard** buttons).

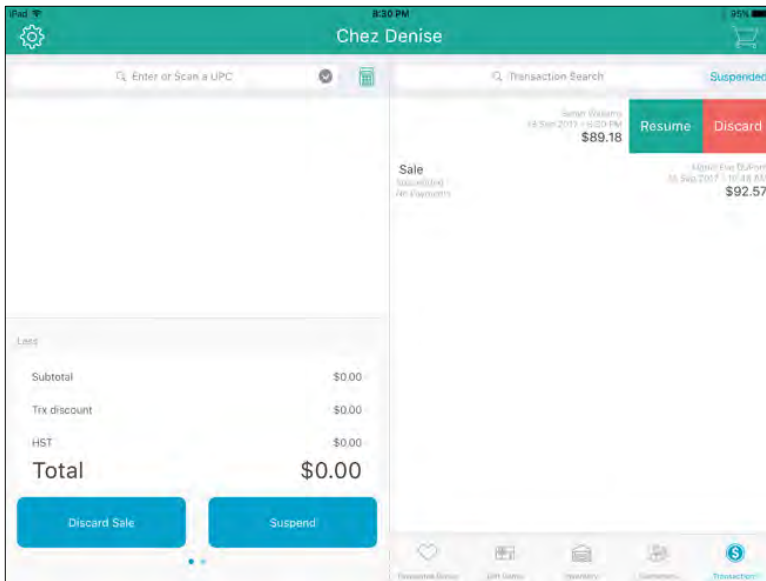

7. Tap the **Discard** button.
8. The transaction disappears from the list and the Transaction Search screen appears.

## Cancelling transactions

It is possible to cancel a transaction before payment has been processed.

1. Tap the total amount at the bottom of the left pane.

A popup appears.

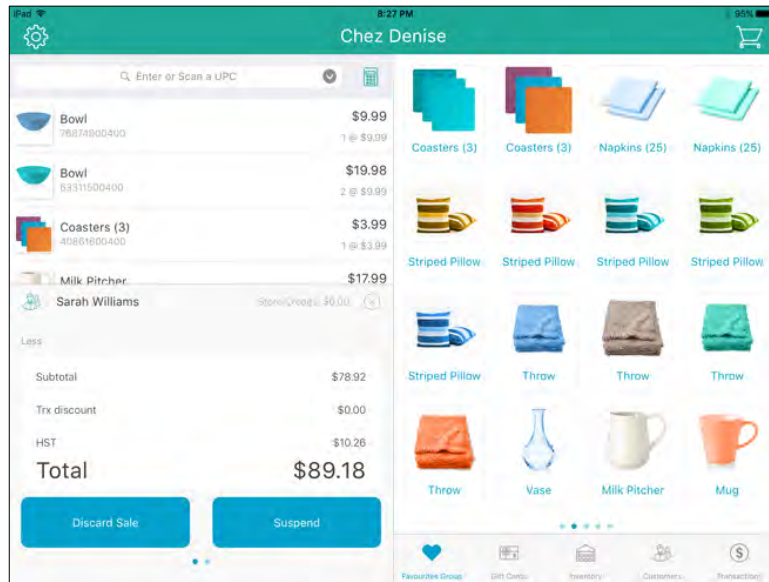

2. Tap **Discard Sale**.

The Sale screen reappears awaiting the start of a new transaction.

## Processing payment

This section explains how to process payments to complete a transaction. Each of the instructions in this section assumes that you have finalized the transaction (e.g., selected the customer, added the items and applied any discounts/price adjustments as necessary).

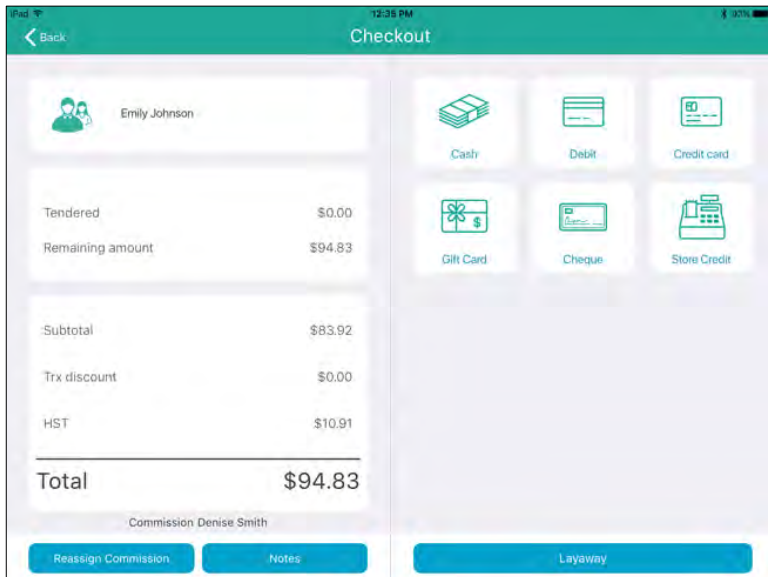

## Reassigning commission

By default, the cashier processing the sale will be the one collecting commission on the sale.

**Note:** For any staff to collect commission, the **Use Commission** setting must be set to **Yes** in the Configuration – Settings screen in PAYD Administration, and staff commission rates must be defined in the employee’s Details screen accessed through PAYD Administration. Tap the **Help** (📄) button in PAYD Administration for more help on configuring commission.

Follow the steps below for reassigning the commission to another employee.

1. Process the sale.
  - If applicable, assign a customer to the sale, adjust quantities and/or prices and apply discounts as necessary.
2. Tap the **Shopping Cart** button (🛒) at the top of the right pane to checkout.  
The Checkout screen appears.
3. Tap the **Reassign Commission** button at the bottom of the left pane.  
A Commission screen appears.

- Use the on-screen keyboard to enter the employee name or ID into the **Commission** search field, and then tap the **Search** key.

**Note:** To search all employees, leave the field blank and tap the **Search** key.

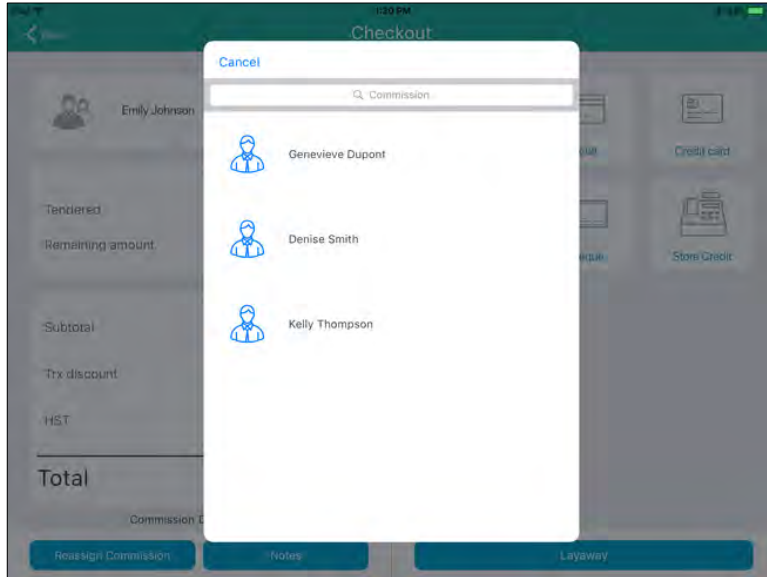

- Tap the employee's name in the search results that appear below.
- Proceed with the transaction by processing payment.

**Note:** If you selected the wrong employee from the list by accident, tap the **X** icon (⊗) that appears beside their name, then repeat steps 3 – 6.

## Processing cash payment

Follow the instructions below to process a cash payment for a transaction.

**Note:** Merchants with a Cash Account will only be able to process cash transactions.

- Tap the **Shopping Cart** button () at the top of the right pane to checkout.  
The Checkout screen appears with the payment types on the right pane.
- Tap **Cash**. The total amount due appears on the left pane.
- Do one of the following:
  - If the customer is providing cash greater than the amount due:**
    - Tap one of the “nearest rounded” amounts on the right pane.

OR

Tap inside the amount field on the right (where the total amount due is showing). The on-screen numberpad appears.
    - Enter the amount the customer has given to you and tap **OK**.

- c. Proceed to step 4.
- **If the customer has exact change:**
  - a. Tap the **OK** button.
  - b. Proceed to step 4.
- **If the customer is paying with US cash:**
  - Toggle the **US Dollars** switch to 'on' (it is 'off' by default). The amount due will automatically switch to show the amount due in US dollars (after the exchange rate has been applied).
- **If the customer is paying with cash and another tender type:**
  - Refer to *Processing split-tender payments* on page 60 for more information.
4. Process the receipts. If change is to be given, the change amount will be displayed on the right pane.
5. Tap **Done** to complete the transaction.

## Processing cheque payment

Follow the instructions below to accept a cheque as payment for a transaction.

1. Tap the **Shopping Cart** button () at the top of the right pane to checkout.  
The Checkout screen appears.
2. Tap **Cheque**.  
The Tendered field populates with the total amount due.
3. Tap the **OK** button.
4. Process the receipts.
5. Tap **Done** to complete the transaction.

## Card entry options

### Insert: chip cards

1. The PIN Pad displays "SWIPE OR INSERT CARD" or "SWIPE, TAP OR INSERT CARD".
2. The customer inserts their card into the PIN Pad's chip reader.  
**Note:** *Unless the PIN Pad prompts otherwise, the card should not be swiped even if it has a magnetic stripe.*
3. The customer may be prompted to enter data, including their PIN.
4. The customer leaves the chip card inserted until "REMOVE CARD" displays on the PIN Pad.

### Tip for proper card insertion:

Hold the PIN Pad with one hand, and insert the card in the chip reader with the other hand. (This will prevent the PIN Pad's embedded contactless reader from inadvertently reading the card data as a contactless transaction.)

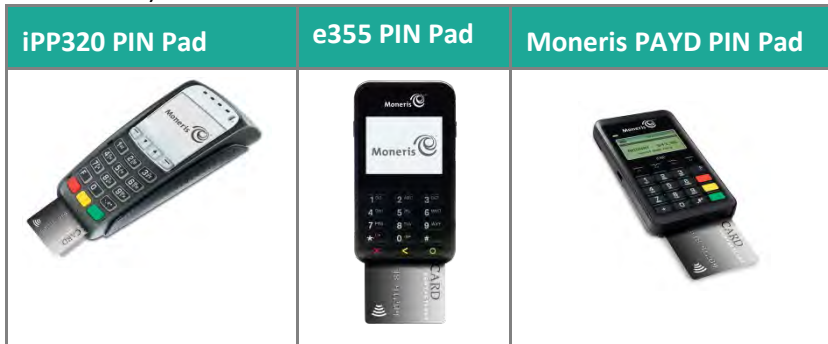

### Swipe: magnetic stripe cards

**Note:** If the card has a chip, it must be inserted (refer to [Insert: Chip cards](#) on page 53).

1. The PIN Pad displays “SWIPE OR INSERT CARD” or “SWIPE, TAP OR INSERT CARD”.
2. You or the customer swipes the card on the PIN Pad's magnetic stripe reader.

**Note:** If the card is a credit card, you should swipe the card.

- If the card is a debit card, the customer will be prompted to enter a PIN.

### Tip for proper card swipe:

Hold the PIN Pad with one hand, and swipe the card in the magnetic stripe reader with the other hand. (This will prevent the PIN Pad's embedded contactless reader from inadvertently reading the card data as a contactless transaction.)

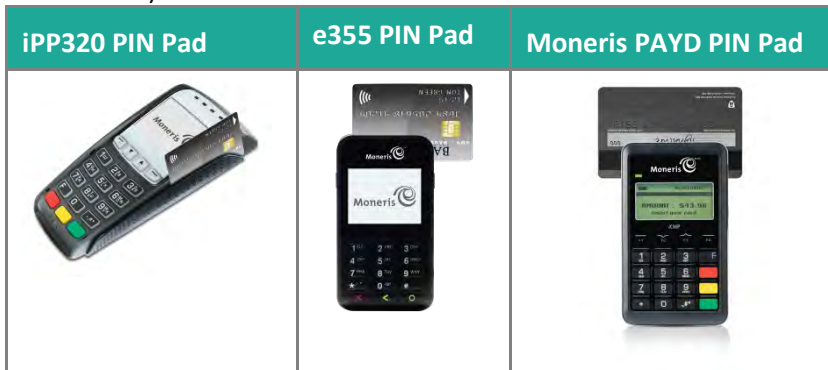

### Wave/tap: Contactless cards

1. The PIN Pad displays “SWIPE, TAP OR INSERT CARD”.
2. The customer taps/waves their card over the PIN Pad's display screen.



3. Note the following:

- For the Moneris PAYD PIN Pad, the PIN Pad's battery charge level should be at least 50% to ensure a successful tap. For the e355 PIN Pad, the battery charge level should be at least 11% to ensure a successful tap. For the iPP320 PIN Pad, there are no battery concerns as the iPP320 doesn't have an internal battery.
- Only Sales and Refunds can be performed as contactless transactions.
- The customer will not be prompted for a PIN.
- The transaction amount must be equal to or less than the maximum Contactless Dollar Value set for the card (refer to *Maximum Contactless Dollar Value* on page 55).

4. The PIN Pad beeps and four green lights flash when the contactless reader is reading the card data.

**Tips for proper card tap/wave:**

- The card must be within 0.5 in. (1.3 cm) of the PIN Pad's display screen, but it does not have to touch it.
- The card must be tapped or waved by itself. It should not be waved while in a wallet with other cards.



**Maximum Contactless Dollar Value (CDV)**

To determine the maximum CDV for a card type, contact us at **1-855-423-PAYD (7293)**.

- **Credit cards:** If a credit card is tapped for an amount that exceeds its maximum CDV, the PIN Pad will display "CONTACTLESS TRANSACTION LIMIT EXCEEDED". Insert the chip credit card (refer to *Insert: Chip cards* on page 53 for more information).
- **Debit cards:** If an *Interac* Debit card is tapped for an amount that exceeds its maximum CDV, the PIN Pad will display "MUST INSERT CARD". Insert the chip credit card (refer to *Insert: Chip cards* on page 53 for more information).

**Swipe: magnetic stripe cards on the PAYD Card Reader**

If something has prevented communication between the PIN Pad and the Apple iPad, you can use the Moneris PAYD Card Reader as a backup method to process credit card transactions.

**Note:** *The PAYD Card Reader cannot be used for Interac Debit transactions.*

1. Insert the PAYD Card Reader into the audio port on the Apple iPad. Turn the Apple iPad volume up to its maximum.
2. Process the transaction.
3. At the Checkout screen, tap **Credit card**.

4. On the right pane, tap **OK**.

The screen displays “Connecting to swiper”, and then the “Please swipe card” prompt appears.

5. Swipe the magnetic stripe slowly through the reader from left to right.
6. Follow the prompts on the screen to complete the transaction.

## Manual card entry

If all available card entry methods fail, you may manually enter the card number for credit cards and some chip debit cards on the PIN Pad.

1. On the right pane of the Checkout screen, tap **Credit card**.
2. On the right pane, tap **Manual Entry**.
3. On a Moneris PIN Pad, enter the credit card number:
  - a. At the “ENTER CARD #” prompt, key in the credit card number. Press the green key when finished.
  - b. At the “EXPIRY DATE MMY” prompt, enter the card’s 4-digit expiry date in MM/YY format. Press the green key when finished.
  - c. Proceed to step 4.
4. Tap **OK**.
5. Wait while the transaction processes.
6. Follow the prompts on the screen to complete the transaction.

## Processing *Interac* Debit payments



Integrated merchants can use a Moneris PIN Pad to accept and process *Interac* Debit cards. Non-integrated merchants must use a different method to process payment for *Interac* Debit cards.

**Note:** *If you are a non-integrated merchant, and you select **Debit** as payment, the following message appears: “Please visit [moneris.com/paydproplus](https://moneris.com/paydproplus) to sign up for credit and debit payment processing.” You will not be able to complete the transaction.*

## Integrated debit payments

Follow the instructions below to process payment using *Interac* Debit and a Moneris PIN Pad. Before proceeding, ensure the following conditions are met:

- For the e355 PIN Pad:
  - Ensure the PIN Pad is powered on and at the WELCOME/BONJOUR screen.
  - Ensure that the e355 PIN Pad is paired to the Apple iPad, or connected to the same network as your Apple iPad via Wi-Fi, and that it has been initialized and is showing a “connected” status () on the main menu. Refer to [Checking Bluetooth device status](#) on page 112 for more information.
- For the iPP320 PIN Pad:
  - Ensure the PIN Pad is powered on and is at the WELCOME/BONJOUR screen.

- Ensure the PIN Pad is selected in the Configuration – Devices screen, and that it has been initialized, and is showing a “connected” status () on the main menu.
- For the PAYD PIN Pad:
  - Ensure the PAYD PIN Pad is powered on and at the WELCOME/BONJOUR screen.
  - Ensure that the PAYD PIN Pad is paired to the Apple iPad, and that it has been initialized and is showing a “connected” status () on the main menu. Refer to [Checking Bluetooth device status](#) on page 112 for more information.

1. Tap the **Shopping Cart** button () at the top of the right pane to checkout.  
The Checkout screen appears.
2. Tap **Debit**.
3. Tap **OK** at the bottom of the right pane. The screen displays “Transaction in progress...”.  
***Note:** If you see the message “PIN Pad connection could not be established”, tap **OK** and refer to the [Troubleshooting](#) section on page 122.*
4. Hand the PIN Pad to the customer.
5. The customer enters their card on the PIN Pad. Refer to [Card entry options](#) on page 53 for more information.
6. The customer follows the prompts on the PIN Pad. Refer to [Customer prompts on the PIN Pad](#) on page 97 for more information.
7. When the payment is successfully processed, the PIN Pad returns to the WELCOME/BONJOUR screen.
8. Retrieve the PIN Pad from the customer.
9. Process the receipts.
10. Tap **Done** to complete the transaction.

## Processing credit card payments





Integrated merchants can use a Moneris PIN Pad or the PAYD Card Reader to accept and process credit cards. Non-integrated merchants must use a different method to process payment from credit cards.

***Note:** If you are a non-integrated merchant, and you select **Credit card** as payment, the following message appears: “Please visit [moneris.com/paydproplus](https://moneris.com/paydproplus) to sign up for credit and debit payment processing.” You will not be able to complete the transaction.*

## Integrated credit payments

Follow the instructions below to process payment using a credit card and a Moneris PIN Pad. Before proceeding, ensure the following conditions are met:

- For the e355 PIN Pad:
  - Ensure the PIN Pad is powered on and at the WELCOME/BONJOUR screen.

- Ensure that the e355 PIN Pad is paired to the Apple iPad, and that it has been initialized and is showing a “connected” status (  ) on the main menu. Refer to [Checking Bluetooth device status](#) on page 112 for more information.
  - For the iPP320 PIN Pad:
    - Ensure the PIN Pad is powered on and is at the WELCOME/BONJOUR screen.
    - Ensure the PIN Pad is selected in the Configuration – Devices screen, and that it has been initialized, and is showing a “connected” status (  ) on the main menu.
  - For the PAYD PIN Pad:
    - Ensure the PAYD PIN Pad is powered on and at the WELCOME/BONJOUR screen.
    - Ensure that the PAYD PIN Pad is paired to the Apple iPad, and that it has been initialized and is showing a “connected” status (  ) on the main menu. Refer to [Checking Bluetooth device status](#) on page 112 for more information.
  - If using the PAYD Card Reader, refer to [Swipe: magnetic stripe cards on the PAYD Card Reader](#) on page 55 for more information.
1. Tap the **Shopping Cart** button (  ) at the top of the right pane to checkout.  
The Checkout screen appears.
  2. Tap **Credit card**.
  3. Tap **OK** at the bottom of the right pane. The screen displays “Transaction in progress...”.  
**Note:** *If you see the message “PIN Pad connection could not be established”, tap **OK** and refer to the [Troubleshooting](#) section on page 122.*
  4. Hand the PIN Pad to the customer.
  5. The customer enters their card on the PIN Pad. Refer to [Card entry options](#) on page 53 for more information.
  6. The customer follows the prompts on the PIN Pad. Refer to [Customer prompts on the PIN Pad](#) on pages 97 to 102 for more information.
  7. When the payment is successfully processed, the PIN Pad returns to the WELCOME/BONJOUR screen.
  8. Retrieve the PIN Pad from the customer.
  9. Process the receipts.
  10. Tap **Done** to complete the transaction.

## Processing Store Credit payments

### Processing a Store Credit belonging to a registered customer

If a customer has received store credit, he or she can redeem it to pay for all or part of a subsequent purchase.

1. Tap the **Shopping Cart** button () at the top of the right pane to checkout.

The Checkout screen appears with the payment types on the right pane. The customer's name and store credit balance appears at the top of the left pane.

2. Tap **Store Credit**.

The right pane populates with the customer's available store credits (there may be more than one).

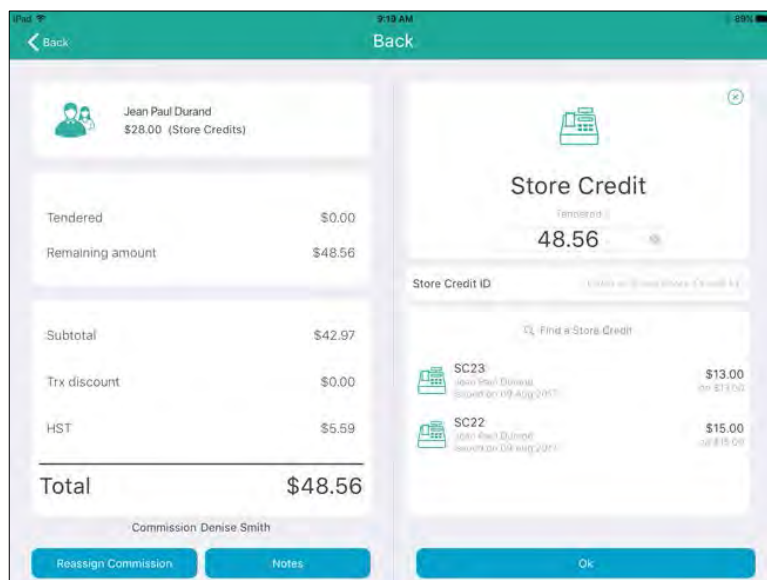

3. Tap the store credit amount the customer wishes to use, then tap **OK**.
4. Process the receipts.
5. Tap **Done** to complete the transaction.

**Note:** If there was not enough store credit to cover the cost of the transaction, you can use the store credit and another tender type to process the transaction as a split-tender transaction. Refer to [Processing split-tender payments](#) on page 60 for more information.

### Processing a Store Credit that belongs to an unregistered customer

If a customer has a store credit, but they have not been registered in the system, you can use the **Store Credit ID**, or search the list of outstanding credits, so that the customer can redeem it to pay for all or part of a subsequent purchase.

1. Tap the **Shopping Cart** button () at the top of the right pane to checkout.



The Checkout screen appears with the payment types on the right pane.

2. Tap **Store Credit**. The total amount due appears on the left pane.
3. On the right pane, do one of the following:
  - **Use the Store Credit ID:**
    - a. If you know the Store Credit ID, tap **Find a Store Credit** and use the on-screen keyboard to enter the ID.
    - b. Tap the **Search** button.  
The search results appear below.
    - c. Tap the store credit you wish to use.  
The customer's name and the credit amount appears.
    - d. Proceed to step 4.
  - **Search for a store credit:**
    - a. Scroll through the list and tap the store credit you wish to use.  
The customer's name and the credit amount appears.
    - b. Proceed to step 4.
4. Tap the store credit amount the customer wishes to use, then tap **OK**.
5. Process the receipts.
6. Tap **Done** to complete the transaction.

**Note:** *If there was not enough store credit to cover the cost of the transaction, you can use the store credit and another tender type and process the transaction as a split-tender transaction. Refer to [Processing split-tender payments](#) below for more information.*

## Processing split-tender payments

It is possible to use **up to two tender types** to process a transaction (e.g., Cash *and* Debit, Cheque *and* Store Credit etc.). Follow the steps below to use two payment types for one transaction.

1. Tap the **Shopping Cart** button () at the top of the right pane to checkout.  
The Checkout screen appears.
2. Tap the first payment type in the right pane.
3. On the right pane, tap inside the **Tendered** field.  
The on-screen numberpad appears with the amount due.
4. Change the amount due to the amount the customer is paying with the first tender type, then tap the checkmark button ()

5. Tap **OK** at the bottom of the right pane.

**Note:** If the transaction involves a debit or credit card, and you see the message “PIN Pad connection could not be established”, tap **OK** and refer to the [Troubleshooting](#) section on page 122.

6. Process the first payment type following the appropriate instructions in this guide.
7. Once complete, the Checkout screen reappears. On the left pane, the remaining amount due is shown (“Remaining amount”).

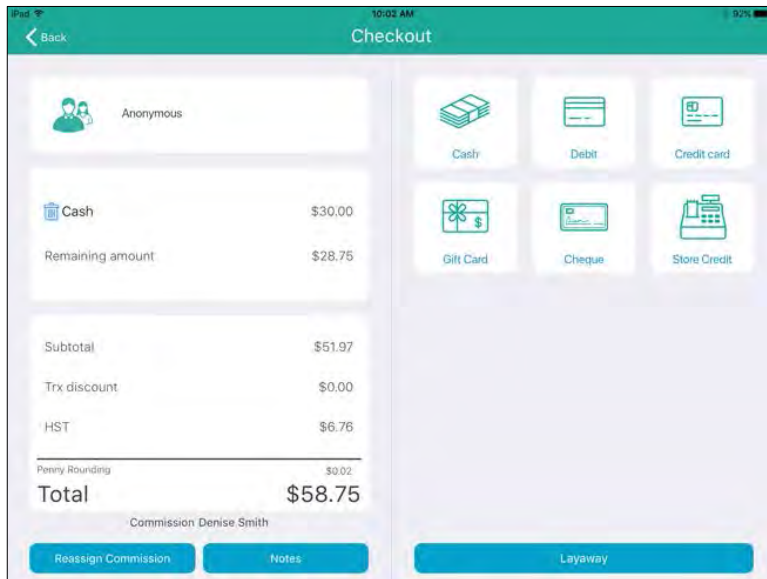

8. Tap the second payment type on the right pane.
9. Process the second payment type following the appropriate instructions in this guide.
10. Process the receipts.
11. Tap **Done** to complete the transaction.

## Processing Moneris gift cards

Moneris gift cards can be processed in the PAYD Pro Plus App using a Moneris e355 PIN Pad, a Moneris iPP320 PIN Pad, or a Moneris PAYD PIN Pad using POSPAD version 1111. Refer to [Determining the PAYD PIN Pad software version](#) on page 94 for more information.

Moneris gift cards can be used as payment. For complete instructions on using Moneris gift cards with the PAYD Pro Plus App, refer to the [PAYD Pro Plus® Mobile Solution: Using PAYD Pro Plus for Gift Cards](#) guide, available at [moneris.com/support-PAYDProPlus-mobile](http://moneris.com/support-PAYDProPlus-mobile).

## Processing layaways

PAYD Pro Plus contains a layaway feature, and layaways can be created, cancelled, completed, or refunded on either the PAYD Pro Plus App, or in PAYD Pro Plus In-Store POS. The instructions in this guide pertain to the PAYD Pro Plus App.

**Note:** *The layaway feature must be enabled in Configuration – Settings screen in PAYD Administration before it can be used in the PAYD Pro Plus App. Click the **Help** () button in the Configuration – Settings screen for more help on layaway configuration.*

## Putting items on layaway

Follow the instructions below to create a layaway.

1. In the Sale screen, assign a customer to the sale. See [Assigning a customer to a sale](#) on page 36 for more information.

**Note:** *A customer must be assigned to the sale in order to process it as a layaway. If the customer is not currently in your customer database, they will need to be added before the layaway can be processed. Refer to [Adding new customers](#) on page 20 for more information.*

2. Add products to the sale. Refer to [Adding products to a sale](#) on page 37 for more information.
3. Adjust quantities and prices (see page 39) and apply discounts (see page 41) as applicable.
4. Tap the **Shopping Cart** button () at the top of the right pane to checkout.

The Checkout screen appears.

5. Determine if the customer is putting down a deposit on their item:
  - If the customer is leaving a deposit:
    - Tap the payment method the customer wishes to use to leave a deposit. Refer to [Taking layaway deposits](#) on page 63 for more information.

OR

- If the customer is not leaving a deposit:
    - Proceed to step 6.
6. Tap the **Layaway** button at the bottom of the right pane.

The Layaway popup appears.



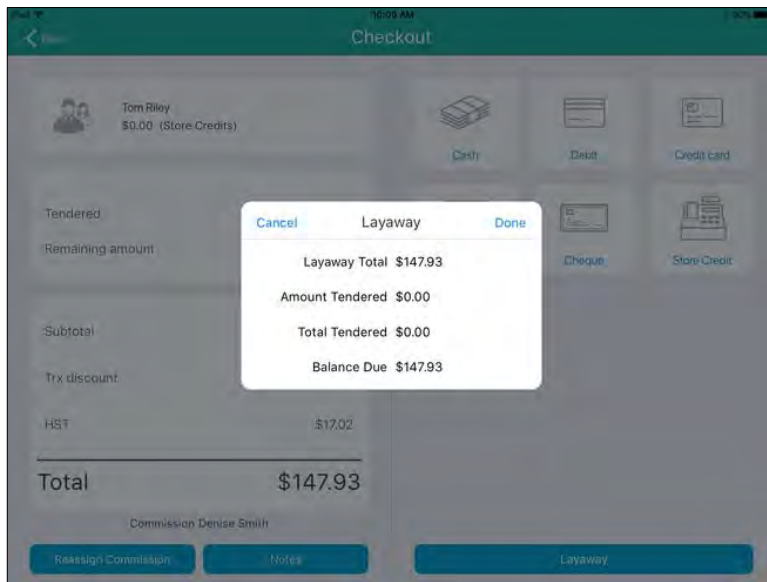

7. Review the information in the popup.
  - If the information in the Layaway popup is *accurate*, tap **Done** and proceed to step 9.
  - If the information in the Layaway popup is *inaccurate*, tap **Cancel** and return to step 6.
8. Process the receipts.
9. Tap **Done** to complete the transaction.

**Note:** Once a layaway is created, it cannot be modified to change items, pricing, quantities, or commissioned staff. The layaway will need to be refunded or cancelled (see page 67 or page 69) and then recreated again following the steps above.

## Taking layaway deposits

Deposits can be paid by any payment type that your store accepts, including any store credits the customer possesses. Follow the instructions below to capture a deposit on a layaway.

1. Begin the transaction; follow steps 1 – 5 of *Putting items on layaway* on page 62.
2. On the right pane of the Checkout screen, tap the payment method the customer is using (e.g., Credit card).
3. In the **Tendered** field on the right pane, enter the amount the customer is putting down as a deposit then tap **OK**.
4. Process the payment. If a credit or debit card is used, hand the PIN Pad to the customer and have them follow the prompts.
5. Once the deposit payment is processed, the Checkout screen reappears.
6. Tap the **Layaway** button at the bottom of the right pane.  
The Layaway popup appears.

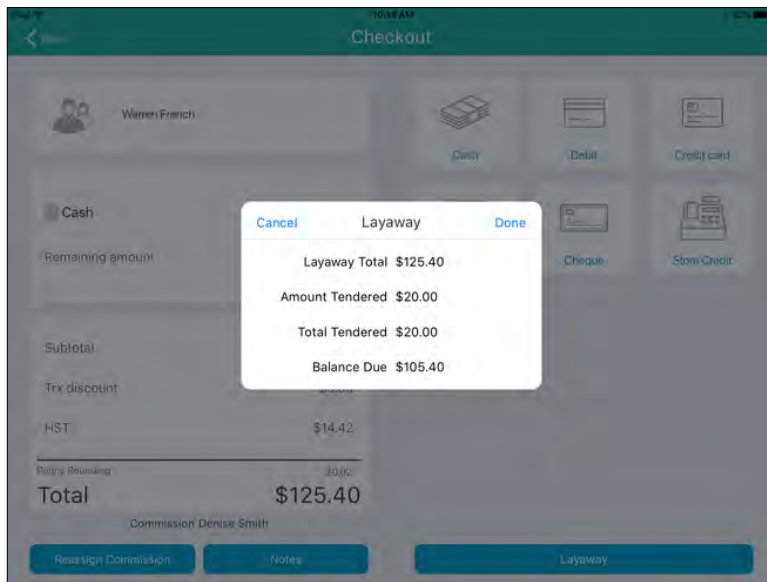

7. Review the information in the popup.
  - If the information in the Layaway popup is *accurate*, tap **Done** and proceed to step 8.
  - If the information in the Layaway popup is *inaccurate*, tap **Cancel** and return to step 6.
8. Process the receipts.
9. Tap **Done** to complete the transaction.

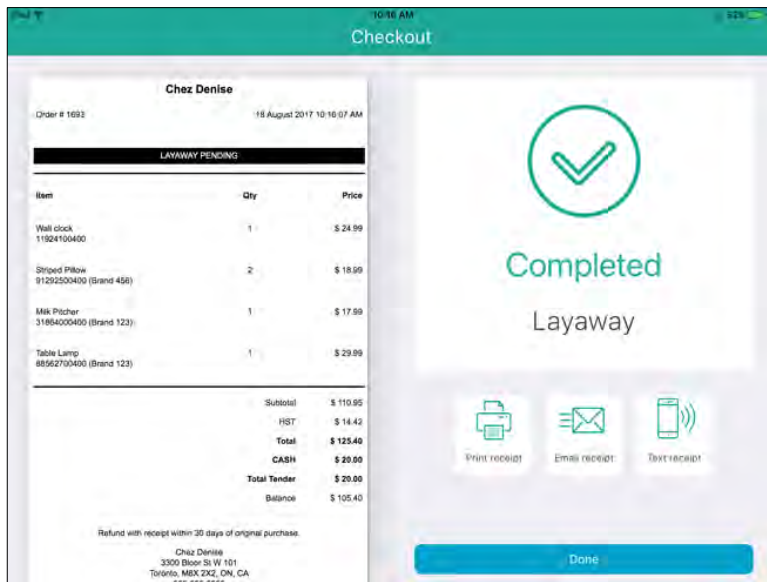

## Making layaway payments

Once a layaway has been started (refer to [Putting items on layaway](#) on page 62), the customer can make payments towards the outstanding balance. Follow the steps below as necessary to accept payments.

1. At the bottom right corner of the Sale screen, tap **Transactions**.

- In the Transactions screen, search for the customer's transaction. Refer to [Searching transactions](#) on page 110 for more information.
- Once you locate the transaction, slide it from right to left, revealing the Cancel, Refund, Deposit, and Edit buttons.

**Note:** The Refund button will only appear if you have made a payment or payments to the layaway.

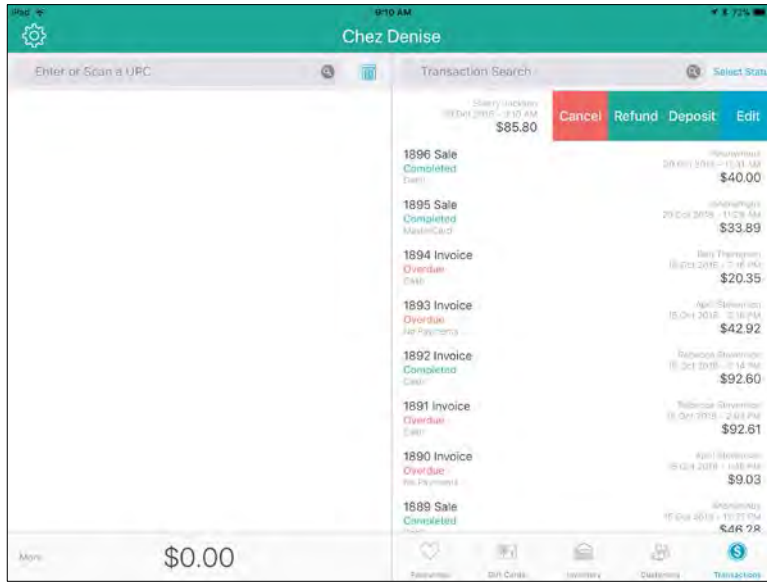

- Tap the **Deposit** button.

The Deposit on Layaway screen appears. The left pane displays the outstanding balance and the amount already paid (if applicable).

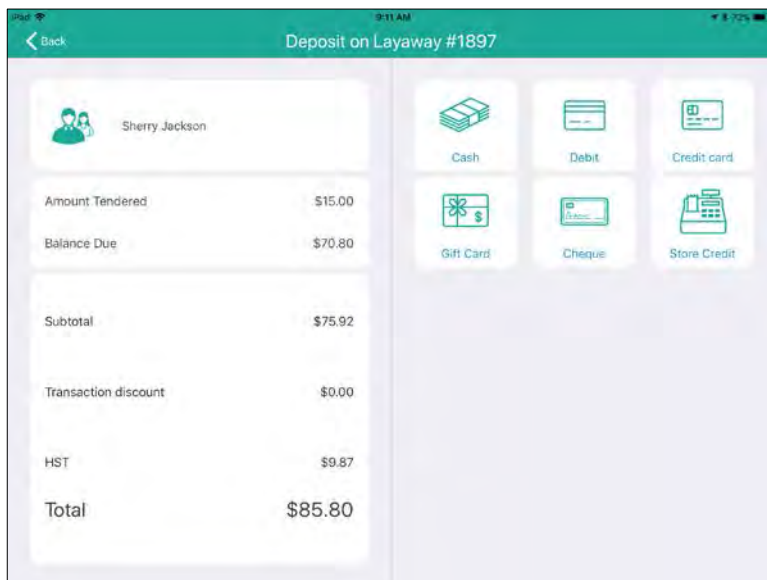

- On the right pane, tap the payment type the customer is using to make the payment e.g. **Credit card**.

- In the **Tendered** field on the right pane, enter the amount the customer is putting down as a deposit, then tap **OK**.
- Process the payment. If a credit or debit card is used, hand the PIN Pad to the customer and have them follow the prompts.
- Once the layaway payment is processed, the receipt appears on the left pane.

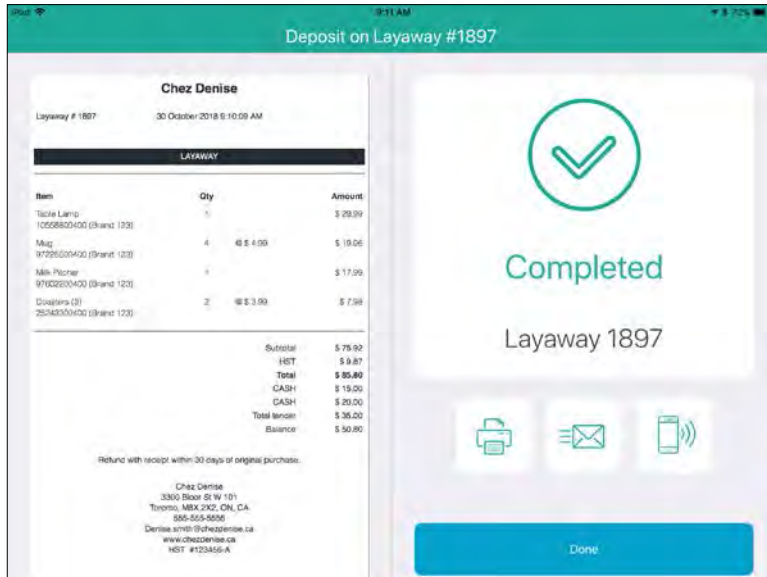

- Process the receipts.
- Tap **Done** to complete the payment transaction.

## Finalizing a layaway

When the customer is ready to pay off their outstanding layaway balance in full, follow the steps below to finalize their layaway.

- Follow steps 1 – 5 in the [Making layaway payments](#) section on page 64.
- In the **Tendered** field on the right pane, enter the amount the customer is paying to pay off the outstanding balance, then tap **OK**.
- Process the payment. If a credit or debit card is used, hand the PIN Pad to the customer and have them follow the prompts.
- Once the layaway payment is processed, the receipt appears on the left pane.
- Process the receipts.

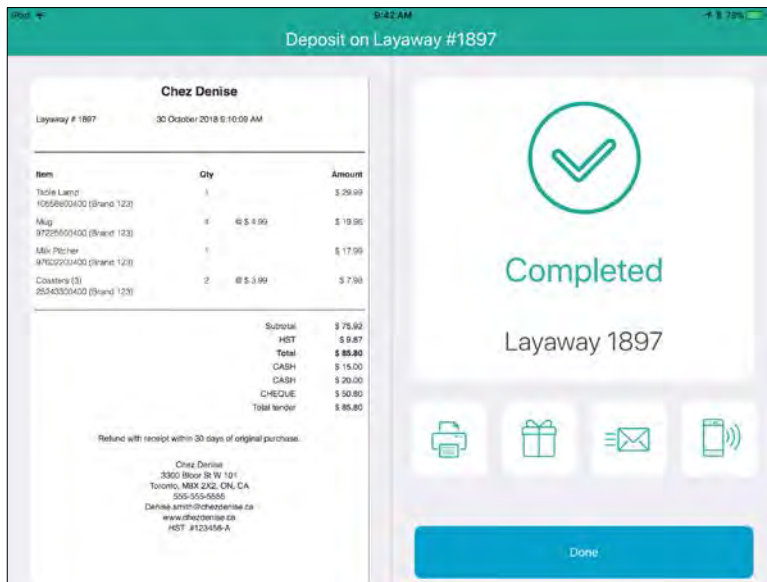

6. Tap **Done** to finalize the layaway transaction.
7. Give the customer their merchandise.

## Refunding layaway payments and transactions

It is possible to refund a layaway deposit, payment, or an entire layaway transaction. Follow these instructions to refund a layaway deposit, payment or an entire layaway transaction.

**Note:** You are unable to refund a layaway that did not have an initial deposit. Refer to [Cancelling layaways](#) on page 69 for more information.

### Refunding layaway deposits and payments

1. At the bottom right corner of the Sale screen, tap **Transactions**.
2. In the Transactions screen, search for the customer's transaction. Refer to [Searching transactions](#) on page 110 for more information.
3. Once you locate the transaction, slide it from right to left, revealing the Cancel, Refund, Deposit, and Edit buttons.
4. Tap the **Refund** button.

The Refund on Layaway screen appears with the transaction details on the left pane and the payment types on the right.

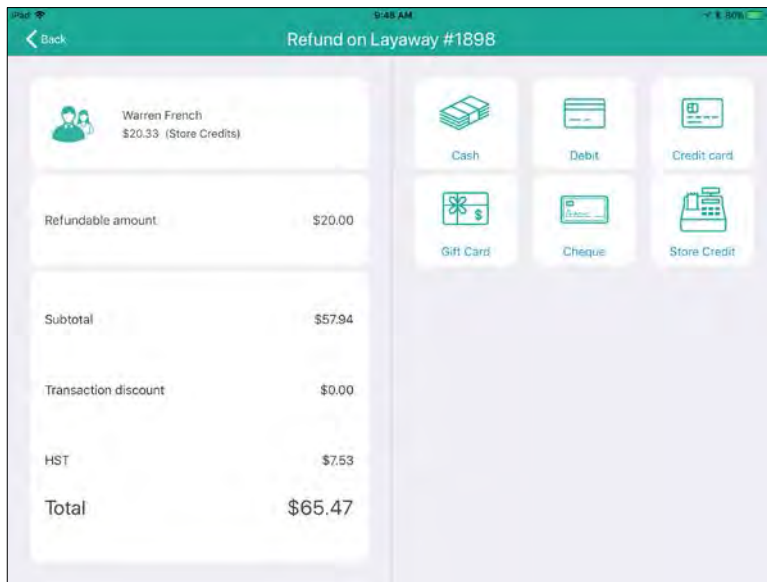

5. Select the payment type to which you are refunding the deposit:
  - To refund to cash, tap **Cash**. In the **Tendered** field on the right pane, enter the refund amount, then tap the checkmark button (). In the Checkout screen, tap **OK**. The drawer opens and you can remove the cash from the till. Proceed to step 6.
  - To refund to cheque, tap **Cheque**. In the **Tendered** field on the right pane, enter the refund amount, then tap **OK**. The drawer opens and you can remove the customer's cheque from the till. Proceed to step 6.
  - To refund to store credit, tap **Store Credit**. Enter the customer's name and phone number in the provided fields, then tap **OK**. Proceed to step 6.
  - To refund to a credit card, tap **Credit Card**. In the **Tendered** field on the right pane, enter the refund amount, then tap **OK**. Hand the PIN Pad to the customer and have them follow the prompts. Proceed to step 6.
  - To refund to a debit card, tap **Debit**. In the **Tendered** field on the right pane, enter the refund amount, then tap **OK**. Hand the PIN Pad to the customer and have them follow the prompts. Proceed to step 6.
6. Process receipts.
7. Tap **Done** to finalize the refund.

## Refunding completed layaway transactions

1. At the bottom right corner of the Sale screen, tap **Transactions**.
2. In the Transactions screen, search for the customer's transaction. Refer to [Searching transactions](#) on page 110 for more information.
3. Once you locate the transaction, slide it from right to left, revealing the **Return** button.
4. Refer to [Processing a Return](#) on page 116 beginning at step 5.

## Cancelling layaways

Cancelling a layaway formally closes it and refunds any deposits taken. Follow the steps below to cancel a layaway.

1. At the bottom right corner of the Sale screen, tap **Transactions**.
2. In the Transactions screen, search for the customer's transaction. Refer to [Searching transactions](#) on page 110 for more information.
3. Once you locate the transaction, slide it from right to left, revealing the Cancel, Refund, Deposit, and Edit buttons.
4. Tap the **Cancel** button.  
A confirmation popup appears.
5. Tap **Yes** to cancel the layaway.  
The transaction receipt appears on the left pane and the payment types appear on the right.
6. Select the payment type to which you are refunding any payments made up to this point:
  - To refund to cash, tap **Cash**. In the **\$** field on the right pane, enter the refund amount, then tap **OK**. The drawer opens and you can remove the cash from the till. Proceed to step 7.
  - To refund to cheque, tap **Cheque**. In the **\$** field on the right pane, enter the refund amount, then tap **OK**. The drawer opens and you can remove the customer's cheque from the till. Proceed to step 7.
  - To refund to store credit, tap **Store Credit**. Enter the customer's name and phone number in the provided fields, then tap **OK**. **Proceed to** step 7.
  - To refund to a credit card, tap **Credit card**. In the **\$** field on the right pane, enter the refund amount, then tap **OK**. Hand the PIN Pad to the customer and have them follow the prompts. Proceed to step 7.
  - To refund to a debit card, tap **Debit**. In the **\$** field on the right pane, enter the refund amount, then tap **OK**. Hand the PIN Pad to the customer and have them follow the prompts. Proceed to step 7.
7. Process receipts.
8. Tap **Done** to finalize the refund.

## Layaway receipts

When a customer begins a layaway, or makes a payment to their outstanding balance, the Merchant and Customer receipts feature the following items that print in addition to the normal transactional information:

### LAYAWAY PENDING

Look for this status printed in white on black near the top of the receipt (under the **Order #** and date/time). This status will print while the layaway is still outstanding. Once the layaway is finalized, this status will no longer appear.

### Payment history

Each time the customer makes a payment on their outstanding balance, the payment type and amount appears on the receipt, and the balance is updated. If the customer paid with a credit or debit card, each instance of

their payment is also shown with the masked card number, date and time, transaction reference number, Auth ID, and amount paid. This payment history helps with refunding individual payments.

For example, if a customer paid their deposit by credit card, and then made two subsequent payments by debit card to pay off the balance, the receipt would display three separate payments, and three instances of the credit and debit payment information.

**Note:** Tap the **Help** button () in PAYD Administration to see an example of a layaway receipt.



## Processing invoices

The invoicing feature enables merchants to create an invoice for the customer's purchase and send it to them via email or SMS text message. Subsequently the customer can pay the invoice directly from a link within the email or SMS message via a Moneris-hosted pay page, or pay it off in-person.

### Activating the invoicing feature

Before the invoicing feature can be used, it needs to be activated within PAYD Administration.

1. Access PAYD Administration (see page 103 for instructions).
2. On the PAYD Administration main screen, tap **Invoicing**.

A popup appears asking if you want to send an approval request to Moneris.

3. Tap **OK**.

A request associated with your Moneris Merchant ID is generated and sent to Moneris for approval and activation. Moneris will notify you to confirm if the invoicing feature has been approved or denied for your business.

**Note:** *The approval can take up to a week to process.*

### Setting invoice options

In PAYD Administration, use the Invoicing Options screen to define how invoices behave, what payment types you can accept, and draft the email that accompanies the customer's invoice.

**Note:** *This setup should be done first before you begin issuing invoices to customers.*

Use the **PAYD Pro Plus Online Help** tool, and search for "Setting Invoice Options" for the explanation of fields and how to configure invoice options within PAYD Administration.

### Producing an invoice

Follow the instructions below to create the invoice to send to the customer.

1. Assign a customer to the sale. See page 36 to assign an existing customer, or see page 37 to create a profile for a new customer.
2. Add products to the invoice. Refer to [Adding products to a sale](#) on page 37 for more information.
3. Adjust quantities and prices (see page 39) and apply discounts (see page 41) as applicable.

4. Tap the **Shopping Cart** button (  ) at the top of the right pane to checkout.

The Checkout screen appears.

5. Determine if the customer is leaving a deposit on their item:

- If the customer is leaving a deposit:
  - Tap the payment method on the right pane that the customer wishes to use to pay their deposit. Refer to the various sections under *Processing payment* for instructions on processing the customer's deposit. When finished processing the deposit, proceed to step 6.

OR

- If the customer is not leaving a deposit:
  - Proceed to step 6.

6. On the right pane of the Checkout screen, tap **Invoice**.

The Invoice popup appears.

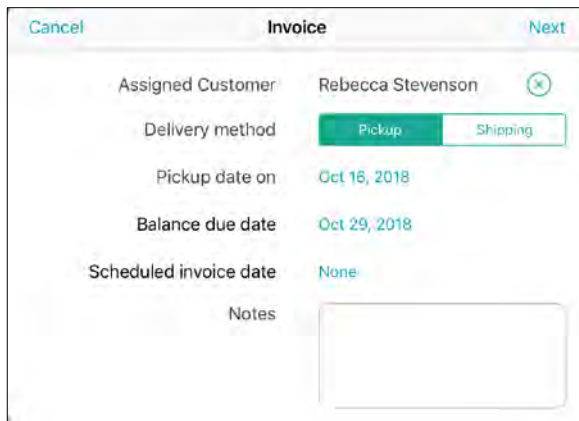

7. Select the **Delivery method**:

- If the customer is picking up their purchase, leave **Pickup** highlighted.
- If the customer is having their purchased items shipped to them, tap **Shipping**.

8. Set the **Pickup or Shipping date**:

- a. Tap the date that appears (by default it displays tomorrow's date).

The Select date popup appears.

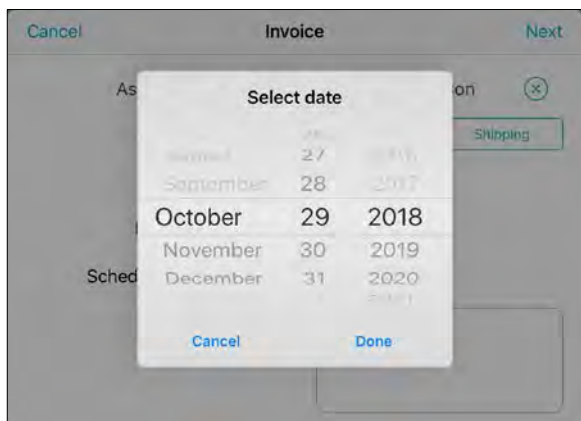

- b. Use the date selector to select the month, day, and year the customer will pick up/have the items shipped.
  - c. Tap **Done** at the bottom of the Select date popup.
9. Set the **Balance due date**:
- d. Tap the date that appears (by default it displays tomorrow's date).  
The Select date popup appears.
  - e. Use the date selector to select the month, day, and year the balance will be due.
  - f. Tap **Done** at the bottom of the Select date popup.
10. If the invoice is to be scheduled to occur at a specific future date (as opposed to today), set the **Scheduled invoice date** using the Select date popup described above. If the invoice will not require scheduling, leave this setting alone.
11. (Optional) Use the **Notes** field to enter additional notes that will appear on the customer's invoice.
12. Tap **Next** in the top right corner of the Invoice popup.
13. Review the invoice details, and if satisfied, tap **Done** in the top right corner of the Invoice popup.
14. In the Checkout screen, select the method by which the customer would like to receive their invoice:
- **Email:** proceed to [Sending invoices via email](#) on page 74 for instructions.
  - **SMS text message:** proceed to [Sending invoices via SMS text](#) on page 75 for instructions.

## Editing invoice details

Once an invoice has been created (as described in [Producing an invoice](#) on page 71), changes can be made to it at any time *before* sending it to the customer using the Invoice popup. If changes are required *after* the invoice has been sent, refer to [Changing sent invoices](#) on page 75.

The screenshot shows the 'Invoice' popup screen with the following details:

- Assigned Customer:** Rebecca Stevenson (with a close icon)
- Delivery method:** Pickup (selected) and Shipping
- Pickup date on:** Oct 16, 2018
- Balance due date:** Oct 29, 2018
- Scheduled invoice date:** None
- Notes:** A text input field.

Edits can include the following items:

- Change the commissioned employee. Refer to [Reassigning commission](#) on page 51 for more information.
- Change the assigned customer. Refer to [Assigning a customer to a sale](#) on page 36 for more information.

- Change the products, quantities, discounts as applicable. Refer to [Editing quantities and prices](#) on page 39 for more information.
- Change the scheduling of due dates, and the delivery method. Follow steps 7-9 in [Producing an invoice](#) on page 71-73 for more information.

## Sending invoices to the customer

Once you have produced the invoice (see page 71) and selected the customer, it is time to send it to them. Follow the instructions below to send the invoice to the customer via email or via SMS text message.

### Sending invoices via email

1. In the Checkout screen, tap the **Email Invoice** () button.

A popup appears.

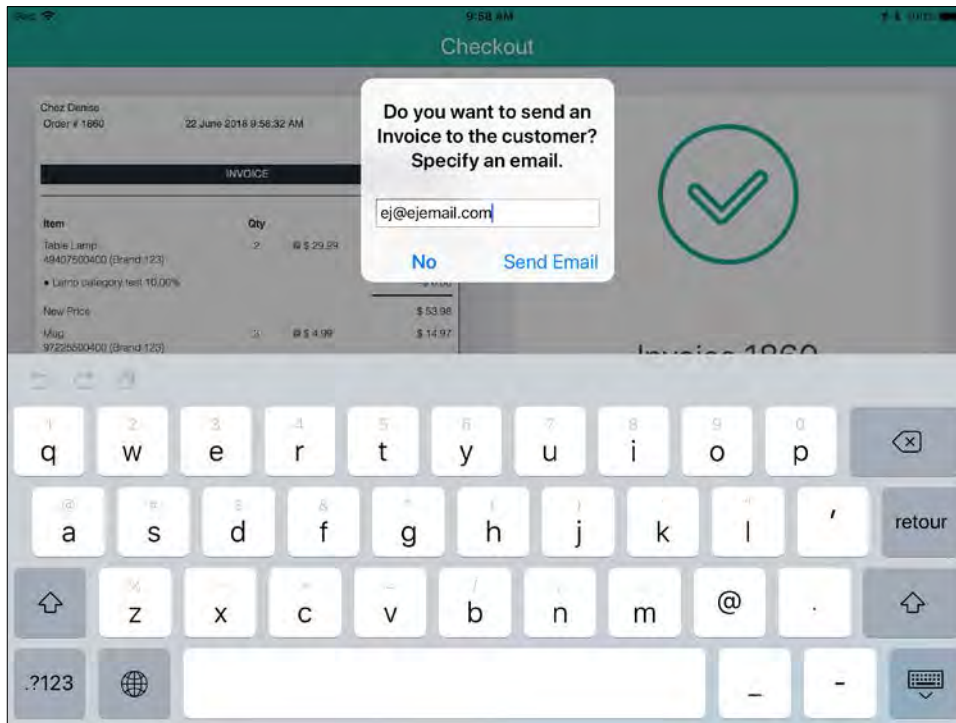

**Note:** The customer's email address may have already populated the popup. If so, confirm the address, tap **Send Email**, and proceed to step 3.

2. Enter the customer's preferred email address and tap **Send Email**.  
The email sends and a popup appears informing you that the email was sent successfully.
3. Tap **OK** on the confirmation popup.
4. Tap **Done** at the bottom of the right pane.

## Sending invoices via SMS text

1. In the Checkout screen, tap the **Text Invoice** () button.

The SMS Invoice popup appears.

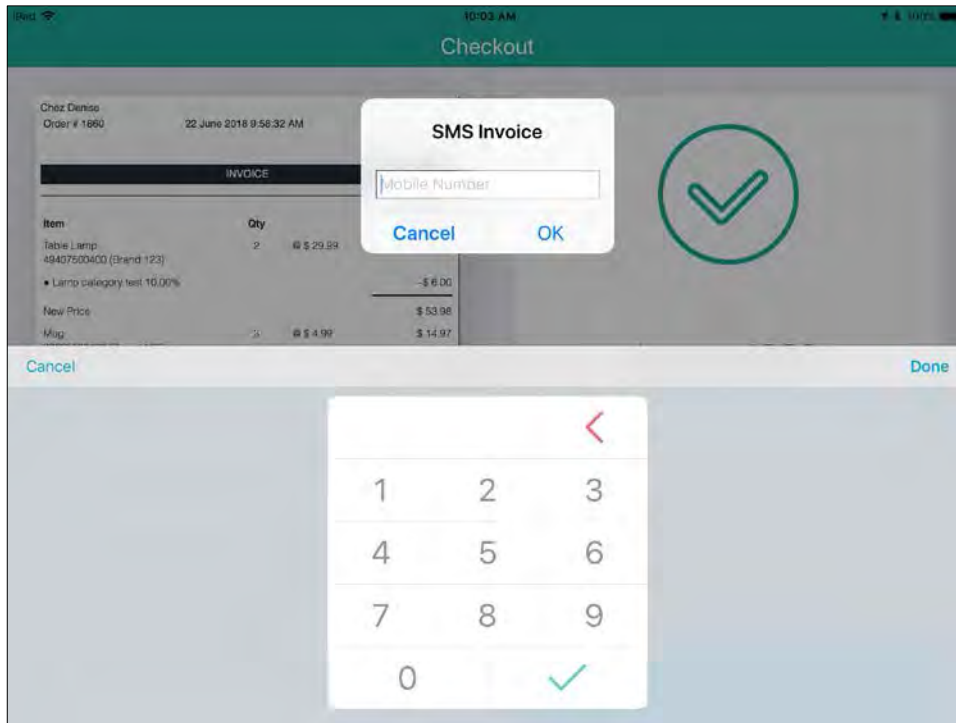

**Note:** The customer's mobile phone number may have already populated the SMS Invoice popup. If so, confirm the number, tap the checkmark button () and proceed to step 3.

2. Enter the customer's preferred mobile phone number and tap the checkmark button ().  
The message sends and a popup appears informing you that it was sent successfully.
3. Tap **OK** on the confirmation popup.
4. Tap **Done** at the bottom of the right pane.

## Changing sent invoices

It is possible to change invoices that have been sent to customers.

**Note:** If a customer has made a payment to their invoice, or has left a deposit, you will only be able to change dates (like the Balance Due date). You can only change details of an invoice (like commissioned staff or product quantities) that has not had any payments made.

1. At the bottom right corner of the Sale screen, tap **Transactions**.

2. In the Transactions screen, search for the customer's transaction. Refer to [Searching transactions](#) on page 110 for more information.
3. Once you locate the transaction, slide it from right to left, revealing the Cancel, Refund, Deposit, and Edit buttons.

**Note:** The Refund button will only appear if you have made a payment or payments to the invoice.

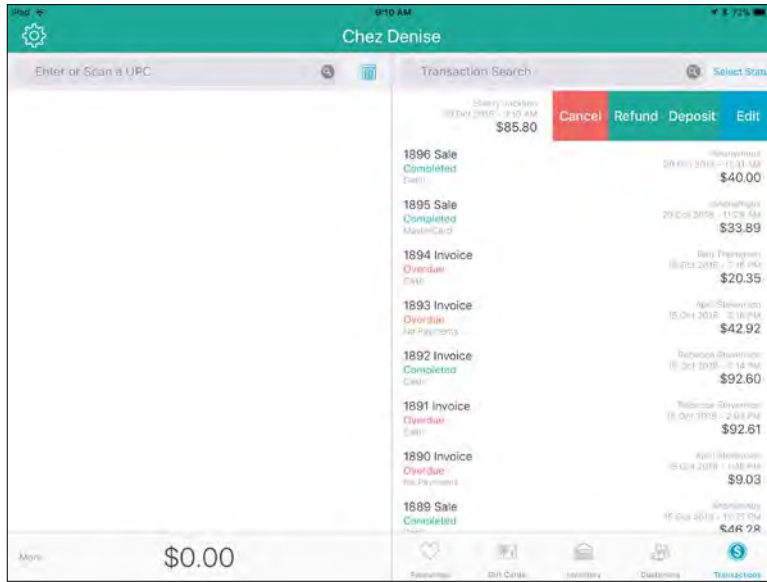

4. Tap **Edit**.  
An Information popup appears.
5. Tap **OK** on the popup.
6. Tap **Edit** at the bottom of the right pane.
7. Make your changes as necessary.
8. Tap **Save** in the top right corner of the screen.
9. Tap the **Receipts** tab at the top of the right pane.
10. Select your method of resending the invoice to the customer:
  - To send the invoice via email:
    - a. Tap **Email**.  
**Note:** If no payment has been made to the invoice, proceed to step c.
    - b. Tap **Email Invoice**.  
The Email Invoice popup appears.
    - c. Use the on-screen keyboard to enter the customer's email address and tap **Return**.  
OR  
Confirm the customer's email address and tap **OK**.
    - d. Proceed to step 11.

- To send the invoice via SMS text:
    - a. Tap **SMS**.
 

***Note:** If no payment has been made to the invoice, proceed to step c.*
    - b. Tap **SMS Invoice**.
 

The SMS Invoice popup appears.
    - c. Use the onscreen numberpad to enter the customer's mobile number and tap the checkmark  button.  
OR  
Confirm the customer's mobile number is correct and tap **OK**.
    - d. Proceed to step 11.
11. When the confirmation appears that the invoice was sent successfully, tap **OK**.
  12. Tap **< Back** at the top of the right pane.
  13. Repeat steps 2 – 12 as necessary to change sent invoices.

## Cancelling invoices

It is possible to cancel an invoice that has not yet been paid for. Follow the steps below to cancel an unpaid invoice.



3. On the Sale screen, tap **Transactions**.
4. Search for the invoice. Refer to [Searching transactions](#) on page 110 for more information.
5. Once you locate the transaction in the list, slide the transaction from right to left revealing the Cancel, Deposit, and Edit buttons.
 

***Note:** If the customer paid a deposit on the invoice, a Refund button will also be visible.*
6. Tap **Cancel**.
 

A confirmation popup appears.
5. In the confirmation popup, tap **Yes**.
 

The Completed screen appears.
6. Do one of the following:
  - To send the cancelled invoice to the customer via email:
    - Tap the **Email** button (). In the Email receipt popup, enter the customer's email address into the field and tap **OK**. Proceed to step 7.
 

***Note:** The customer's email address may have already populated the popup. If so, confirm the address, tap **OK**, and proceed to step 7.*
    - To send the cancelled invoice to the customer via SMS text message:

- Tap the **SMS Text** button (). In the Text Receipt popup, enter the customer's mobile phone number into the field and tap the checkmark button (). Proceed to step 7.

**Note:** The customer's mobile phone number may have already populated the popup. If so, confirm the number, tap the checkmark button () and proceed to step 7.

- At the bottom of the right pane, tap **Done**.

The invoice is cancelled.

## Customer invoice payment

The customer can pay the invoice either in person, or online.

### Paying the invoice in person

If the customer is picking up their invoiced items, they can pay their outstanding balance in person. Follow the instructions below to capture an in-person payment.

- On the Sale screen, tap **Transactions**.
- Search for the invoice. Refer to [Searching transactions](#) on page 110 for more information.
- Once you locate the invoice in the list, slide it from right to left revealing the Cancel, Deposit, and Edit buttons.
- Tap **Deposit**.

The Invoice # popup appears.

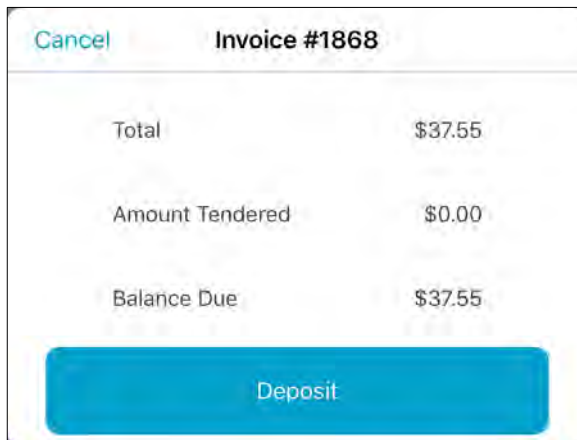

Invoice #1868	
Total	\$37.55
Amount Tendered	\$0.00
Balance Due	\$37.55

Deposit

- Tap **Deposit**.

The Deposit on Invoice # screen appears.



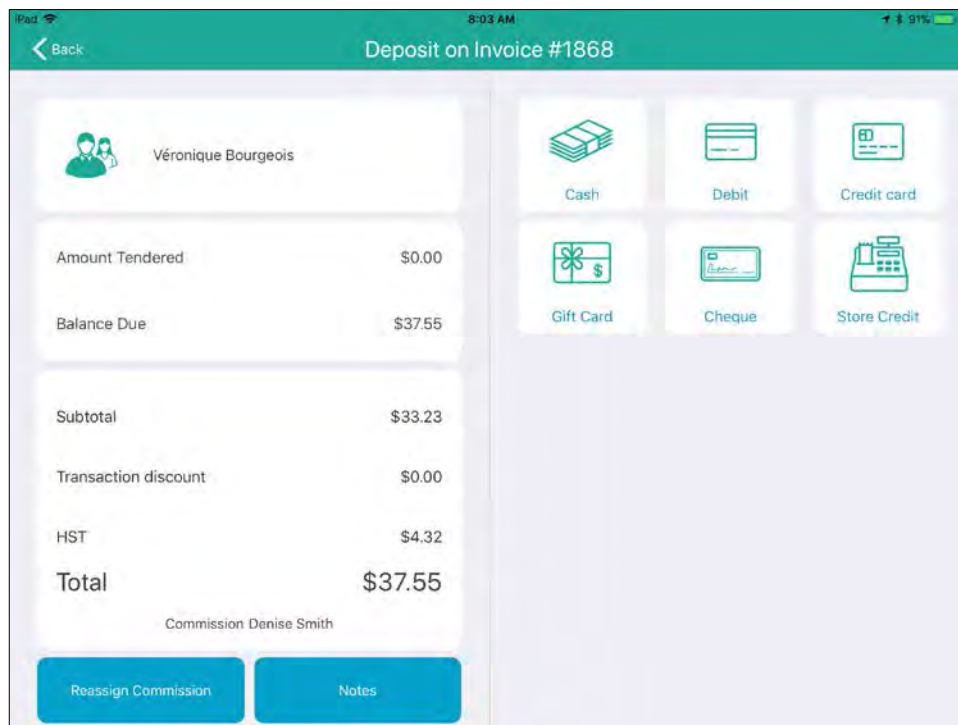



6. On the right pane, tap the payment method the customer wishes to use.
7. Process the payment (see page 51 for more information), then process the receipts (see page 84).

### Paying the invoice from an emailed link

If the customer opted to receive the invoice via email, they will receive an email from your business' email address with a link to a secure hosted pay page. The customer enters their card information on the page and clicks/taps **Process transaction**.

**Note:** The screenshot below shows the hosted pay page on a computer's web browser. The customer can also use an email app and the mobile device's web browser to access the hosted pay page.

Chez Denise  
Order # 1868 27 June 2018 7:16:33 AM

VISA   DISCOVER

INVOICE		
Item	Qty	Amount
Bowls (4) 28287500400 (Brand 123)	1	\$ 14.99
• Discount 5.00%		-\$ 0.75
New Price		\$ 14.24
Vase 45992900400 (Brand 123)	1	\$ 19.99
• Discount 5.00%		-\$ 1.00
New Price		\$ 18.99
	Subtotal	\$ 33.23
	HST	\$ 4.32
	<b>Total</b>	<b>\$ 37.55</b>
	CASH	\$ 20.00
	Total tender	\$ 20.00
	Balance	\$ 17.55

\* Card Number

\* Security Code

\* Expiry Month

\* Expiry Year

\* Balance due  
**\$ 17.55**

**Process transaction**

\* Mandatory Fields

After **Process transaction** is clicked/tapped, the card is processed and the result is returned.

If the transaction is approved, you are notified via email that the invoice has been paid and you are ready to take the next steps e.g. ship the items to the customer.

Chez Denise  
Order # 1868 27 June 2018 7:16:33 AM

Item	Qty	Amount
Bowls (4) 28287500400 (Brand 123)	1	\$ 14.99
• Discount 5.00%		-\$ 0.75
New Price		\$ 14.24
Vase 45992900400 (Brand 123)	1	\$ 19.99
• Discount 5.00%		-\$ 1.00
New Price		\$ 18.99
	Subtotal	\$ 33.23
	HST	\$ 4.32
	<b>Total</b>	<b>\$ 37.55</b>
	CASH	\$ 20.00
	VISA	\$ 17.55
	Total tender	\$ 37.55

## Paying the invoice from an SMS text

If the customer opted to receive the invoice via SMS text message, they will receive a text from your store on their mobile device with a link to a secure hosted pay page. The customer enters their card information on the page and clicks/taps **Process transaction**.



After **Process transaction** is clicked, the card is processed and the result is returned.

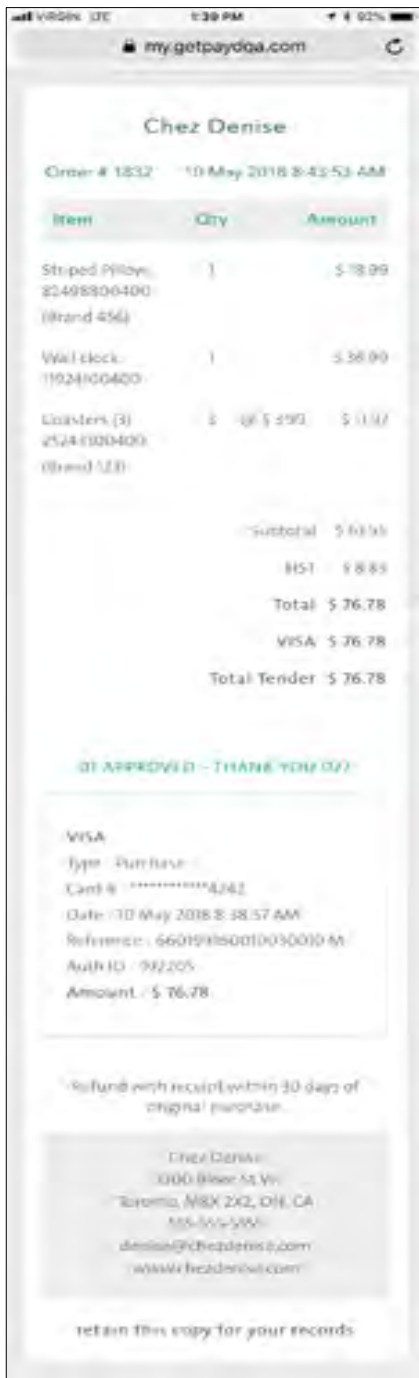

If the transaction is approved, you are notified via email that the invoice has been paid and you are ready to take the next steps e.g. ship the items to the customer.

## Refunding invoices

It is possible to refund an invoice payment, or a fully paid invoice. Follow the directions below to process a refund.

## Refunding invoice payments

1. On the Sale screen, tap **Transactions**.
2. Search for the invoice. Refer to [Searching transactions](#) on page 110 for more information.
3. Once you locate the transaction in the list, slide the transaction from right to left revealing the Cancel, Refund, Deposit, and Edit buttons.
4. Tap **Refund**.  
The Invoice # popup appears.
5. Tap the **Refund** button.  
The Refund on Invoice # screen appears.
6. Select the payment type on the right pane to which the deposit is being returned.
7. Refer to [Processing a Return](#) on page 116, beginning at step 8, for more information.

## Refunding a completed invoice

1. On the Sale screen, tap **Transactions**.
2. Search for the invoice. Refer to [Searching transactions](#) on page 110 for more information.
3. Once you locate the transaction in the list, slide the transaction from right to left revealing the Return button.
4. Tap **Return**.  
The Select product(s) to return popup appears.
5. Tap the quantities of the products the customer is returning, then tap **Done**.  
The Return on Sale screen appears.
6. Refer to [Processing a Return](#) on page 116, beginning at step 8, for more information.

## Receipt options

There are 4 types of receipts that can be generated by the PAYD Pro Plus App: receipts printed from the Bluetooth receipt printer, emailed receipts, SMS text receipts, and gift receipts printed from the Bluetooth receipt printer.

The receipts you are able to generate are dependent upon the type of hardware connected to your Apple iPad, as well as the output options you have enabled in the Configuration - Receipts screen. For more information on configuring receipt layout and output options, refer to the **PAYD Pro Plus® Mobile Solution: Configuration Guide** available at [moneris.com/support-PAYDProPlus-mobile](https://moneris.com/support-PAYDProPlus-mobile).

## Generating printed receipts

For printed (hardcopy) receipts, you have the option of printing only a customer copy, a merchant copy, or both. You can also have the receipts print automatically at the end of each transaction, or on demand. Before printing receipts, ensure the following conditions are met:

- The Bluetooth receipt printer is powered on and paired to the Apple iPad. For more information on pairing the printer to the Apple iPad, refer to the **PAYD Pro Plus® Mobile Solution: Hardware Install Guide** available at [moneris.com/support-PAYDProPlus-mobile](https://moneris.com/support-PAYDProPlus-mobile).
- Ensure the Bluetooth receipt printer is showing connected () on the main menu. Refer to [Checking Bluetooth device status](#) on page 112 for more information.
- Ensure there is enough paper on the roll in the printer to print receipts.

**Note:** *If you have a receipt printer and cash drawer, the drawer will not open until the transaction completes and the receipt prints. The receipt printer controls when the drawer opens.*

### To generate printed receipts automatically:

- No action required. When the transaction completes, the Customer copy, Merchant copy, or both, will print.

### To generate printed receipts on demand:

- After the sale completes, *before tapping Done*, tap the **Print receipt** button (). The Customer copy of the receipt will print.

## Generating email receipts

The PAYD Pro Plus App can email a copy of the receipt to the customer.

1. Complete the transaction and process the payment(s).

2. Before tapping **Done**, tap the **Email receipt** button ().

The Email receipt popup appears.

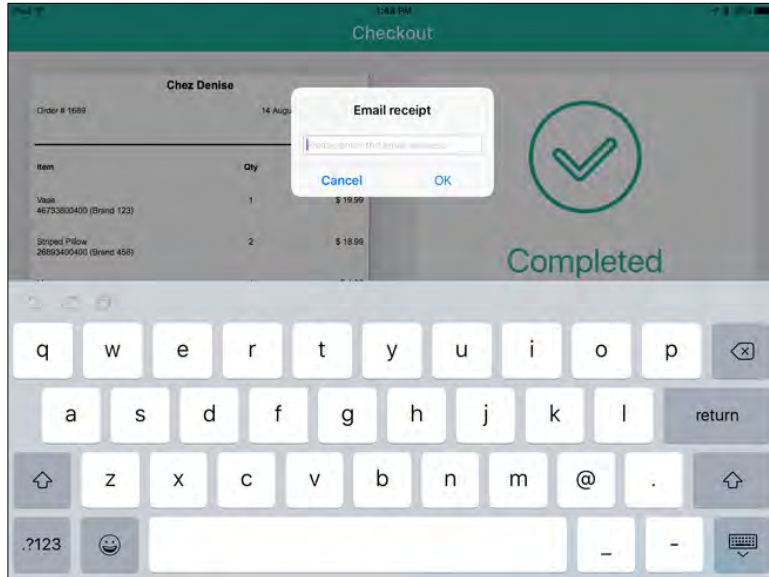

3. Do one of the following:
  - **If the customer making the purchase is already registered as a customer in your database:**
    - The customer's email address may be visible (if you recorded that information in the customer profile at an earlier time). Confirm the email address is correct and tap **OK**. Proceed to step 4.
    - If the email address is not present, or is not correct, tap inside the provided field and use the on-screen keyboard to enter the customer's email address, then tap **OK**. Proceed to step 4.
  - **If the customer making the purchase is not yet in your database:**
    - Tap inside the **provided** field and use the on-screen keyboard to enter the customer's email address, then tap **OK**. Proceed to step 4.
4. The PAYD Pro Plus App sends the email to the customer.
5. Tap **Done** to complete the transaction.

## Generating SMS text receipts

The PAYD Pro Plus App can send a link to the Customer copy of the receipt to the customer's mobile phone as an SMS text message.

**Note:** Based upon your PAYD Pro Plus software bundle and/or your Merchant Agreement with Moneris, you may encounter a limit to the number of SMS receipts you can send. You are responsible for any fees imposed by your mobile service provider. For more information on how to increase this limit, please visit us at [moneris.com/paydproplus](http://moneris.com/paydproplus) or call us at **1-855-423-PAYD (7293)** to upgrade today.

1. Complete the transaction and process the payment(s).

- Before tapping **Done**, tap the **Text receipt** button ().
- The Text Receipt popup appears.

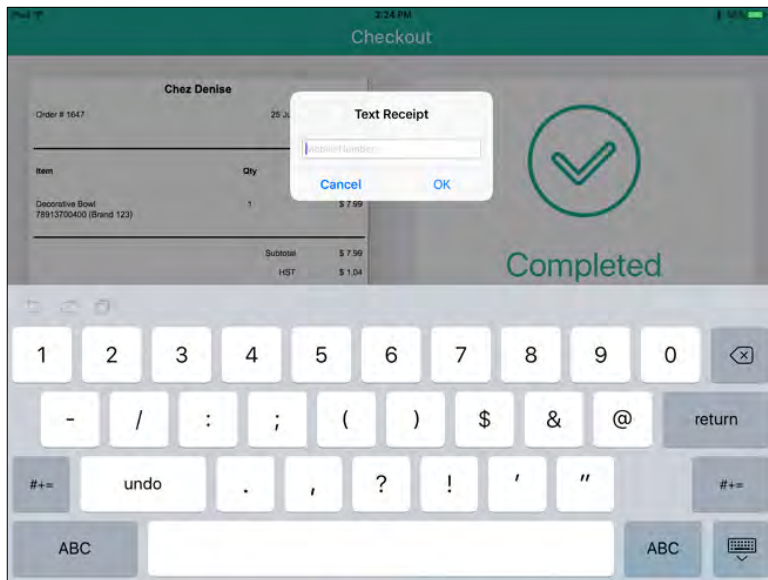

- Enter the customer's mobile phone number in the **Mobile Number** field and tap **OK**.
- The PAYD Pro Plus App sends a text message to the customer containing a link to the Customer copy of the receipt.
- Tap **Done** to complete the transaction.

## Generating gift receipts

When completing a transaction, you have the option to issue a gift receipt to the customer.

- Complete the transaction and process the payment(s).
- Before tapping **Done**, tap the **Gift Receipt** button ().

The Select Gift Receipt Items popup appears, with a list of every product that was on the bill.



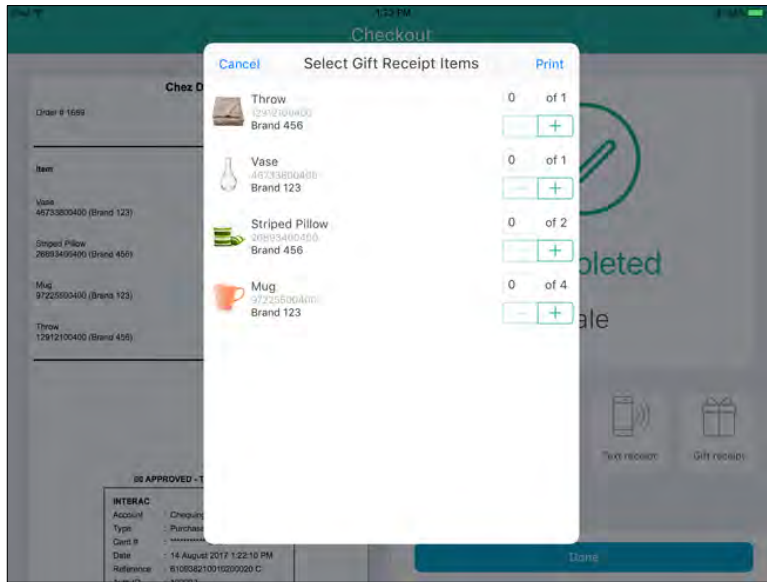



3. Tap the + symbol to the right of the items you wish to add to the gift receipt. In instances where multiples of the same item were purchased, tap + as often as necessary to add the appropriate quantity to the bill. For example, if a customer purchases 5 of the same puzzle, and wants 2 of them to be on a gift receipt, tap + until the quantity shows 2.
4. Repeat step 3 for other items on the bill.
5. Tap **Print** in the top right corner of the popup to continue.  
The gift receipt prints from the Bluetooth receipt printer.
6. Generate other receipts as necessary then tap **Done**.

## Reprinting transaction receipts

It is possible to reprint receipts after the initial transaction has been completed. You can also print a gift receipt, email or text the customer another copy of the receipt if requested.

1. At the bottom right corner of the Sale screen, tap **Transactions**.
2. Search for the transaction you wish to reprint. For more help on searching for transactions, refer to [Searching transactions](#) on page 110.
3. Once you locate the transaction in the list, tap it.  
The right pane loads with the receipt details.
4. Select your receipt output:

- To reprint a customer copy, tap the **Print receipt** button (  ).
- To email a customer copy, tap the **Email receipt** button (  ).

- To send a customer copy as an SMS text message, tap the **Text receipt** button ().



- To generate a gift receipt, tap the **Gift receipt** button ().

5. When finished, tap **<Back** at the top of the right pane.

## Optional devices

### The Moneris e355 PIN Pad



1	<b>Power indicator light</b> (right side of the e355)
2	<b>Micro-USB port</b> (right side of the e355) <ul style="list-style-type: none"><li>▪ Plug in the USB charging cable here.</li></ul>
3	<b>Cancel key</b> (red)  <ul style="list-style-type: none"><li>▪ Clear a displayed message, or cancel a transaction.</li><li>▪ Power off the e355 (press and hold down until the e355 beeps and starts to power off).</li></ul>
4	<b>Correct key</b> (yellow)  <ul style="list-style-type: none"><li>▪ Clear data entered on the e355.</li></ul>
5	<b>OK/Enter key</b> (green)  <ul style="list-style-type: none"><li>▪ Submit data or acknowledge a message on the e355.</li><li>▪ Power on the e355 (press and hold down until the e355 starts to power up).</li></ul>

6	<p><b>Chip Reader</b> (slot at the bottom of the e355)</p> <ul style="list-style-type: none"> <li>▪ Insert debit/credit chip cards into the slot. Refer to <i><u>Insert: Chip cards</u></i> on page 53.</li> </ul>
7	<p><b>Display Screen/Contactless Reader</b></p> <ul style="list-style-type: none"> <li>▪ The WELCOME/BONJOUR screen displays while the PIN Pad is idle.</li> <li>▪ Refer to <i><u>Wave/tap: Contactless cards</u></i> on page 55.</li> </ul>
8	<p><b>Magnetic Stripe Reader</b> (slot along the top of the e355)</p> <ul style="list-style-type: none"> <li>▪ Swipe debit/credit cards in the slot (see page 54).</li> </ul>
9	<p><b>Contactless Reader Indicator</b> (green flashing lights)</p> <ul style="list-style-type: none"> <li>▪ Four lights flash: The contactless reader is capturing card data (see page 54).</li> </ul>



For more information on setting up the e355 PIN Pad to use with the PAYD Pro Plus App, refer to the **Moneris e355 with PAYD Pro Plus®: Quick Install Guide** available for download at [moneris.com/support-PAYDProPlus-mobile](https://moneris.com/support-PAYDProPlus-mobile), or the **PAYD Pro Plus Online Help**.

## The Moneris iPP320 PIN Pad

The customer uses the iPP320 PIN Pad to input payment data when prompted during a transaction.



1	<p><b>Contactless Reader Indicator</b> (green flashing lights)</p> <ul style="list-style-type: none"><li>Four lights flash: The contactless reader is capturing card data (see page 54).</li></ul>
2	<p><b>Display Screen/Contactless Reader</b></p> <ul style="list-style-type: none"><li>The WELCOME/BONJOUR screen displays while the PIN Pad is idle.</li><li>Refer to <i>Wave/tap: Contactless cards</i> on page 54.</li></ul>
3	<p><b>Function keys (F1, F2, F3, and F4)</b></p> <ul style="list-style-type: none"><li>Select the option displayed above the key.</li><li><b>F2</b> and <b>F3</b> are used to scroll up and down through menus.</li></ul>
4	<p><b>Alpha-Numeric keys</b></p> <ul style="list-style-type: none"><li>Used for data entry (e.g., PINs or tip amounts).</li></ul>
5	<p><b>Magnetic Stripe Reader</b></p> <ul style="list-style-type: none"><li>Refer to <i>Swipe: magnetic stripe cards</i> on page 54.</li></ul>

6	<p>Cancel key </p> <ul style="list-style-type: none"> <li>▪ Clear a message displayed on the PIN Pad.</li> <li>▪ Cancel the transaction.</li> </ul>
7	<p>Correct key </p> <ul style="list-style-type: none"> <li>▪ Clear data entered on the PIN Pad.</li> </ul>
8	<p>OK / Enter key </p> <ul style="list-style-type: none"> <li>▪ Submit data, or acknowledge a message displayed on the PIN Pad.</li> </ul>
9	<p>Chip Reader</p> <ul style="list-style-type: none"> <li>▪ Refer to <i>Insert: Chip cards</i> on page 53.</li> </ul>



For more information on setting up the iPP320 PIN Pad to use with the PAYD Pro Plus App, refer to the **Moneris iPP320 with PAYD Pro Plus®: Quick Install Guide** available for download at [moneris.com/support-PAYDProPlus-mobile](https://moneris.com/support-PAYDProPlus-mobile), or the **PAYD Pro Plus Online Help**.

## The Moneris PAYD® PIN Pad

The customer uses the PAYD PIN Pad to input payment data when prompted during a transaction.



1	<p><b>Function keys (F1, F2, F3, and F4)</b></p> <ul style="list-style-type: none"> <li>Select the option displayed above the key.</li> <li><b>F2</b> and <b>F3</b> are used to scroll up and down through menus.</li> </ul>
2	<p><b>Alpha-Numeric keys</b></p> <ul style="list-style-type: none"> <li>Used for data entry (e.g., PINs or tip amounts).</li> </ul>
3	<p><b>Cancel key</b> </p> <ul style="list-style-type: none"> <li>Clear a message displayed on the PAYD PIN Pad.</li> <li>Cancel the transaction.</li> </ul>

4	<p><b>Correct key</b> </p> <ul style="list-style-type: none"> <li>Clear data entered on the PAYD PIN Pad.</li> </ul>
5	<p><b>OK / Enter key</b> </p> <ul style="list-style-type: none"> <li>Submit data, or acknowledge a message displayed on the PAYD PIN Pad.</li> </ul>
6	<p><b>Chip Reader</b> (the slot at the bottom of the PAYD PIN Pad)</p> <ul style="list-style-type: none"> <li>Refer to <i><u>Insert: Chip cards</u></i> on page 53.</li> </ul>
7	<p><b>Contactless Reader Indicator</b> (green flashing lights)</p> <ul style="list-style-type: none"> <li>No lights flash: PAYD PIN Pad is in Sleep mode, or is powered off.</li> <li>One light flashes: Reader is fully powered on.</li> <li>Four lights flash: Reader is capturing card data (see page 54).</li> </ul>
8	<p><b>Display Screen/Contactless Reader</b></p> <ul style="list-style-type: none"> <li>WELCOME/BONJOUR screen displays while the PAYD PIN Pad is idle.</li> <li>Refer to <i><u>Wave/tap: Contactless cards</u></i> on page 54.</li> </ul>
9	<p><b>Magnetic Stripe Reader</b> (the slot along the top of PAYD PIN Pad)</p> <ul style="list-style-type: none"> <li>Refer to <i><u>Swipe: magnetic stripe cards</u></i> on page 54.</li> </ul>
10	<p><b>Micro-USB port</b> (located on the right side)</p> <ul style="list-style-type: none"> <li>Plug in the USB charging cable here.</li> </ul>
11	<p><b>Power button</b> (located on the right side)</p> <ul style="list-style-type: none"> <li>For reset function, press and hold down until the rebooting process starts.</li> </ul>

For more information on setting up the PAYD PIN Pad to use with the PAYD Pro Plus App, refer to the **Moneris PAYD® PIN Pad with PAYD Pro Plus: Quick Install Guide** available for download at [moneris.com/support-PAYDProPlus-mobile](https://moneris.com/support-PAYDProPlus-mobile), or the **PAYD Pro Plus Online Help**.

## Determining the PAYD PIN Pad software version

The software version appears in the version info screen as the PAYD PIN Pad starts up. Refer to the diagram below to determine the software version on the PAYD PIN Pad.



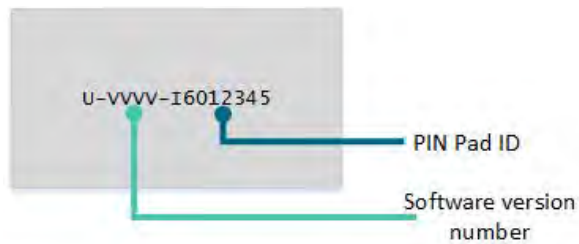

The **XXXX** value depicted in this diagram corresponds to the software version, and can be one of three values: **0608**, **0614**, or **1111**. This version will determine whether or not you can use the Moneris Gift Card program with your PAYD PIN Pad.

## The Moneris PAYD card reader

If you are unable to perform a credit card transaction using a Moneris PIN Pad, follow the steps below to use the PAYD card reader as a backup device. To order a PAYD card reader, please contact us at [1-855-423-PAYD \(7293\)](tel:1-855-423-PAYD).

1. Make sure the media speaker on your Apple iPad is turned off.
2. Ensure that the volume level of your Apple iPad is maximized.
3. Connect the PAYD card reader to your Apple iPad by plugging it into the audio jack.



## Bluetooth barcode scanner

Use the Bluetooth barcode scanner to scan barcodes when processing transactions, adding inventory, searching for products, or searching for receipts. The barcode scanner is an optional device. To purchase a Bluetooth barcode scanner, please contact us at [1-855-423-PAYD \(7293\)](tel:1-855-423-PAYD).



## Bluetooth receipt printer

Use the Bluetooth receipt printer to print receipts when transactions are completed. It is possible to connect a cash drawer to the printer. The receipt printer and cash drawer are optional devices. To purchase a Bluetooth receipt printer and a cash drawer, please contact us at [1-855-423-PAYD \(7293\)](tel:1-855-423-PAYD).



## Dymo LabelWriter

Use a Dymo LabelWriter to print product barcode labels from PAYD Administration. To purchase a Dymo LabelWriter, please contact us at [1-855-423-PAYD \(7293\)](tel:1-855-423-PAYD).











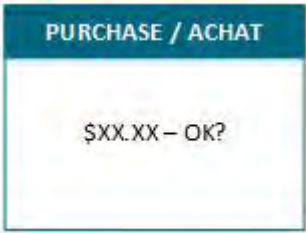

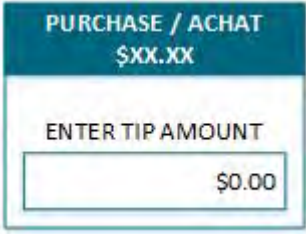

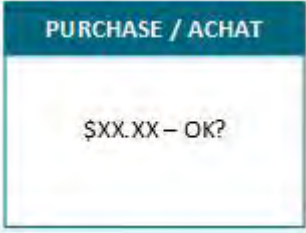
## Customer prompts on the PIN Pads

These tables display the prompts (in order of their appearance) that your customers might see during a POS transaction on a Moneris PIN Pad, along with the actions to take for each one.

**Note:** Only some of the prompts listed will appear for any one transaction.

### Customer prompts on the e355 PIN Pad

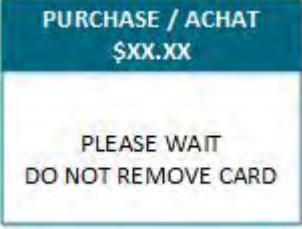
Prompt	Customer action(s)
	Confirms the amount of the purchase. Presses the green  key.
	<ul style="list-style-type: none"> <li>Keys in the amount to leave for tip and presses the green  key.</li> </ul> OR <ul style="list-style-type: none"> <li>Presses green  key to bypass the prompt (and not leave a tip).</li> </ul>
	Confirms the amount of the purchase + tip (if entered at the previous prompt). Presses the green  key.
	Enters the card on the PIN Pad (refer to <a href="#">Card entry options</a> on pages 53- 56).

Prompt	Customer action(s)
	<ul style="list-style-type: none"> <li>▪ For chequing, presses the <b>1</b> key.</li> <li>▪ For savings, presses the <b>3</b> key.</li> </ul>
	<p>Keys in the Personal Identification Number (PIN) and presses the green  key.</p>
	<p>Waits while the transaction is processed.</p>
	<p>This appears if the card was tapped or inserted.</p> <ul style="list-style-type: none"> <li>▪ Retrieves the card.</li> </ul> <p>OR</p> <ul style="list-style-type: none"> <li>▪ Removes the card from chip reader.</li> </ul> <p><b>Note:</b> <i>The PIN Pad beeps until the card is removed.</i></p>
	<p>This appears if the card was tapped.</p>

Prompt	Customer action(s)
	Returns the PIN Pad to you.

## Customer prompts on the iPP320 and PAYD PIN Pads

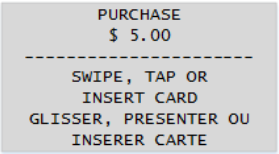
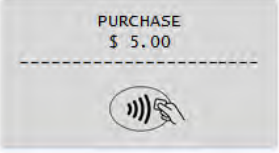
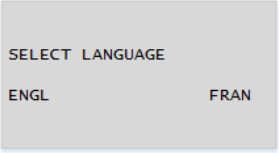
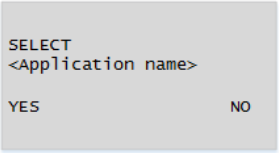
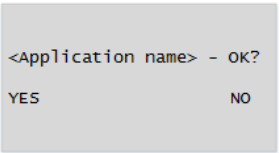
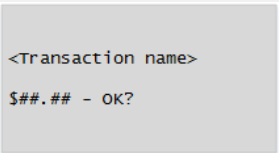
Prompt	Customer action(s)
 <p>or</p> 	Enters the card on the PIN Pad (refer to <i>Card entry options</i> on pages 53- 56).
	<p>The card entered has dual languages.</p> <ul style="list-style-type: none"> <li>For English prompts, presses <b>F1</b> (ENGL).</li> <li>For French prompts, presses <b>F4</b> (FRAN).</li> </ul>
	<p>The card has dual applications e.g., debit and credit.</p> <ul style="list-style-type: none"> <li>To select the displayed application, presses <b>F1</b> (YES).</li> <li>To view the next available application, presses <b>F4</b> (NO).</li> </ul>
	<p>The card has dual applications e.g., debit and credit, and one was selected at the previous Select prompt.</p> <ul style="list-style-type: none"> <li>Presses <b>F1</b> (YES) to use the displayed application.</li> <li>Presses <b>F4</b> (NO) to return to the previous Select prompt.</li> </ul>
	Presses the green key to confirm the displayed transaction amount.

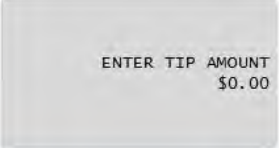
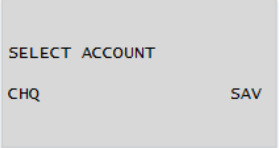
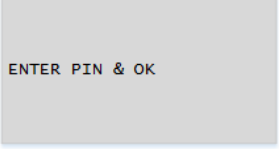
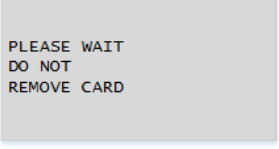
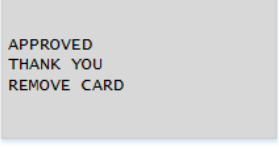
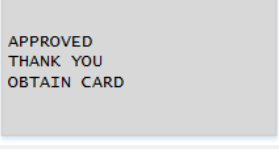
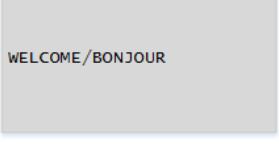
Prompt	Customer action(s)
	<ul style="list-style-type: none"> <li>▪ Keys in the amount to leave for tip and presses the green key.</li> </ul> <p>OR</p> <ul style="list-style-type: none"> <li>▪ Presses green key to bypass the prompt (and not leave a tip).</li> </ul>
	<ul style="list-style-type: none"> <li>▪ For chequing, presses <b>F1</b> (CHQ).</li> <li>▪ For savings, presses <b>F4</b> (SAV).</li> </ul>
	<p>Keys in the Personal Identification Number (PIN) and presses the green key.</p>
	<p>Waits while the transaction is processed.</p>
	<p>Removes the card from chip reader.</p> <p><b>Note:</b> <i>The PIN Pad beeps until the card is removed.</i></p>
	<p>Retrieves the card.</p>
	<p>Returns the PIN Pad to you.</p>



# Administrative transactions

This section explains how to perform administrative operations in the PAYD Pro Plus App.

## Accessing Help

The PAYD Pro Plus App has a help menu that provides links to external help resources, including:

- Access to the PAYD Pro Plus support page to view FAQs and downloadable PDF guides
- Account and billing details in Merchant Direct
- Contact the PAYD Pro Plus support team via Facebook, Twitter, or live chat

To access the help menu:

1. Tap the **Settings** button ()
2. On the main menu, tap **Help**.

The Help screen appears with the various help options.

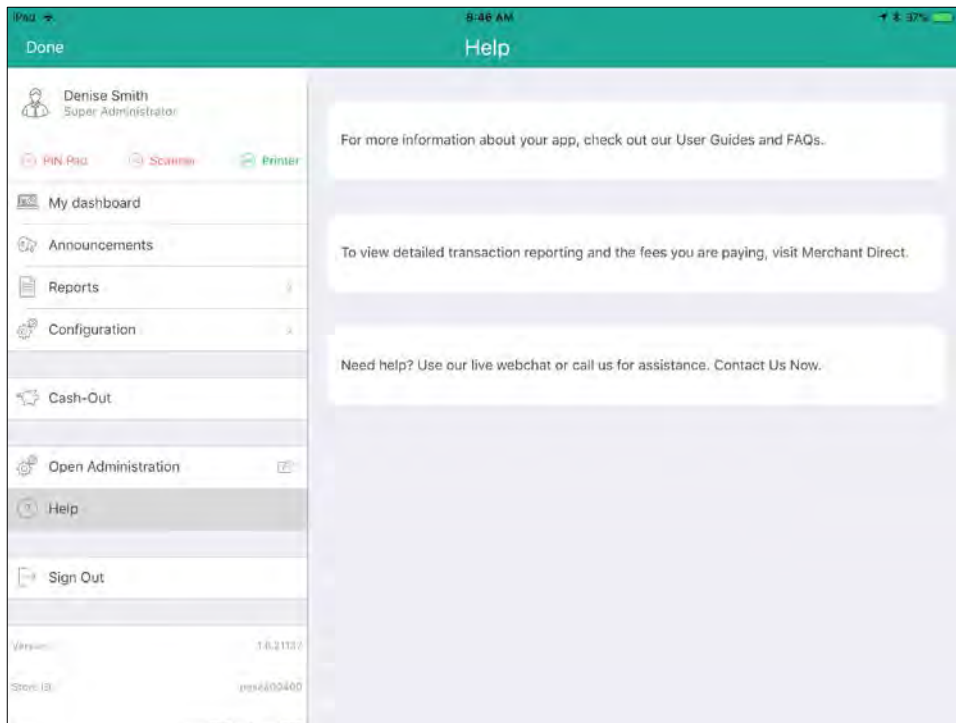



## Accessing PAYD Administration

The PAYD Pro Plus App has a companion; Moneris PAYD Administration. PAYD Administration runs in a separate window, and contains many additional tools. Based on your Merchant Agreement with Moneris and your PAYD account type, the available tools may include additional reporting, customer and inventory management, additional data setup and software configuration settings, an email marketing engine, Ecommerce website design etc.

To access PAYD Administration:

1. Tap the **Settings** button ()
2. On the main menu, tap **Open Administration**.
3. The Moneris PAYD Administration screen appears. You are automatically logged in with the same PAYD login credentials you used to log in to the PAYD Pro Plus App.

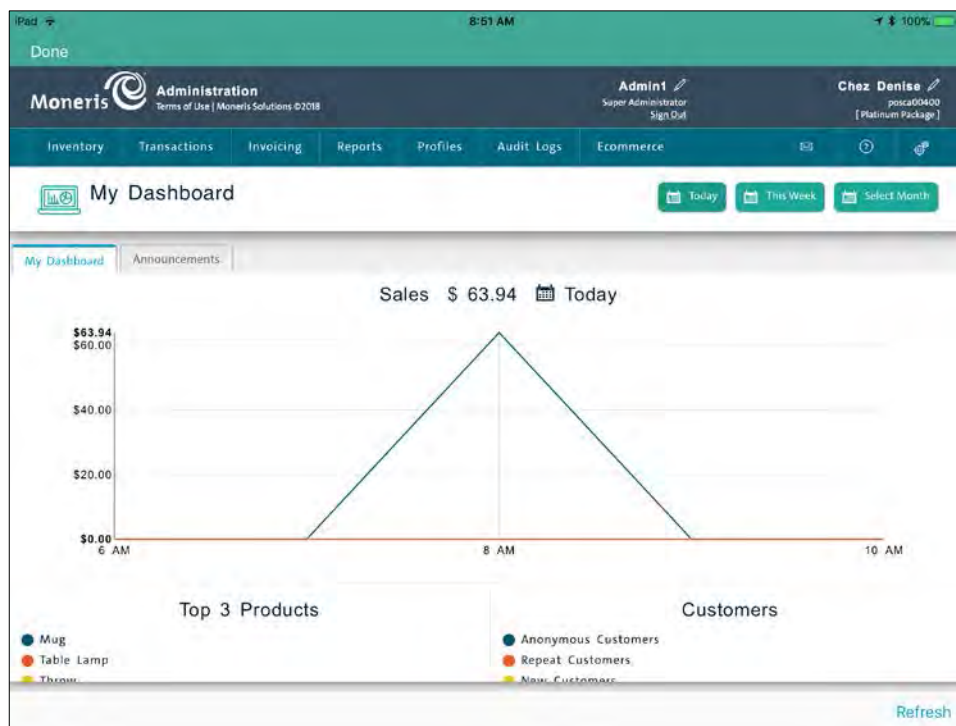

4. When you are finished using the Administration functions, tap **Done** in the top left corner of the screen.

**Note:** Tap the **Help** () button in the PAYD Administration screen to consult the **PAYD Pro Plus Online Help** for more information on operating the software.

## Changing the automatic logout time

The PAYD Pro Plus App has both an automatic lock and automatic logout timer that can be configured to lock the app and/or log the current user out of the app after a designated amount of inactivity time. These settings are configured in PAYD Administration. Follow the instructions below to access and change the automatic inactivity lock and logout settings.

1. Access PAYD Administration. Refer to [Accessing PAYD Administration](#) on page 103 for more information.
2. In the PAYD Administration main screen, tap the **Settings** icon (  ) in the top right corner of the screen.
3. On the General options menu, tap **Settings**.
4. In the Settings screen, under the **Inactivity Period** section, enter a value (in minutes) into the **POS Session Locks After** field.

For example, if you enter a value of 2, the PAYD Pro Plus App will lock after two minutes of idle time and require the current user to log back in with their quick PIN, their fingerprint, or their PAYD logon password.

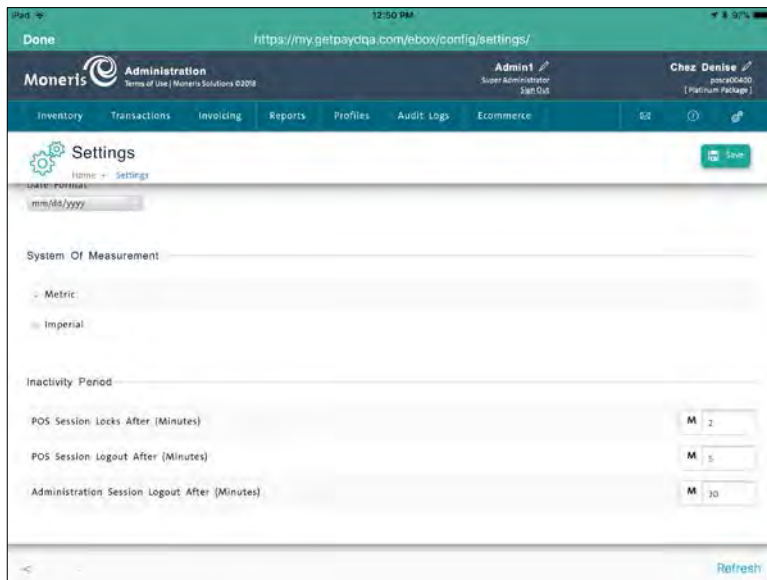

5. Enter a value (in minutes) into the **POS Session Logout After** field.  
For example, if you enter a value of 5, the PAYD Pro Plus App will automatically log out after five minutes of inactivity and will return to the login screen.
6. Tap the **Save** button in the top right corner of the screen.
7. Tap **Done** in the top left corner of the screen.  
The main menu appears again.
8. Tap **Done** to return to the Sale screen.

## Logging in after session lock

Once the session locks after the predefined period of inactivity (refer to step 4 of [Changing the automatic logout time](#) on page 104), the Authentication popup appears. Follow the instructions below to unlock the PAYD Pro Plus App.

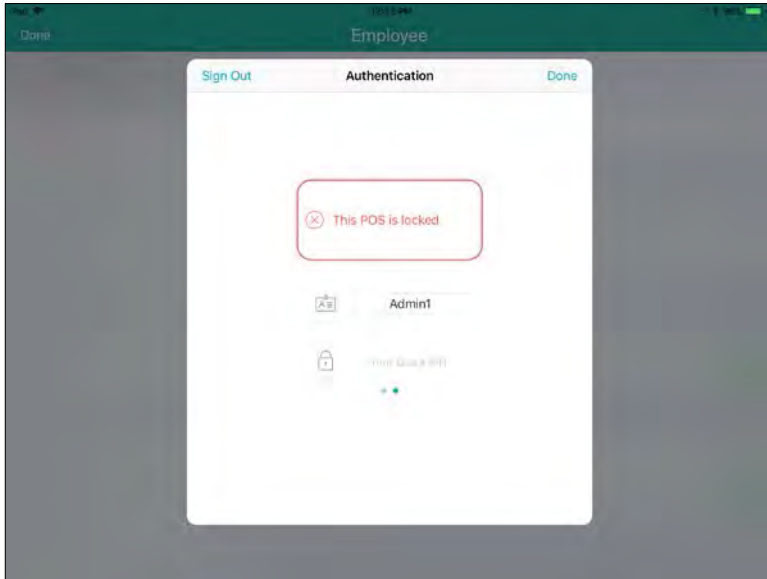

**Note:** Depending on the App's configuration, you may need to scroll left or right to access the login type applicable to your employee profile.

1. In the Authentication popup, do one of the following based on your login configuration:
  - If you have a quick PIN configured:
    - e. Tap **Your Quick PIN**.  
The numeric keypad appears.
    - f. Enter your quick PIN and tap the checkmark .

The numeric keypad disappears and your session is restored to the last screen you were using.
  - If you have a fingerprint configured:
    - a. At the Authentication screen, tap **Use Touch ID**.
    - b. At the **Touch ID** prompt, touch or press the **Home** button on the Apple iPad.  
Your session is restored to the last screen you were using.
  - If you have the standard login configured:
    - a. The **User ID** and **Store ID** will already be populated with your settings.
    - b. Tap **Password**.
    - c. Use the on-screen keyboard to enter your password.

- d. Tap **Return** on the on-screen keyboard.

The on-screen keyboard disappears and your session is restored to the last screen you were using.

## Logging in after automatic logout

The login process after you've been automatically logged out is the same as the process after you have voluntarily logged out. Refer to [\*Signing in to the PAYD Pro Plus App\*](#) on page 6 for instructions.

## Processing Payouts

Use the Payouts tool when you need to reduce the amount of cash in your till, or to pay for an incidental cost (like tipping a courier or sending an employee to the store to buy stamps).

**Note:** Payouts impact cash totals (the amount expected), and are reflected as a separate transaction type throughout the PAYD Pro Plus App and PAYD Administration where applicable.

**Note:** The Payout feature must be enabled and configured in the Configuration – Settings screen in PAYD Administration before it will be visible in the PAYD Pro Plus App. Refer to [Accessing PAYD Administration on page 103](#) for more information. For instructions on enabling and configuring Payouts, access the **PAYD Pro Plus Online**

**Help** tool (by tapping the **Help**  button) and searching for the topic called “Configuring Other Merchant Settings”.

To process a payout:

1. From the Sale screen, tap the **Settings** button ().
2. On the main menu, tap **Payout**.

The Payout popup appears.

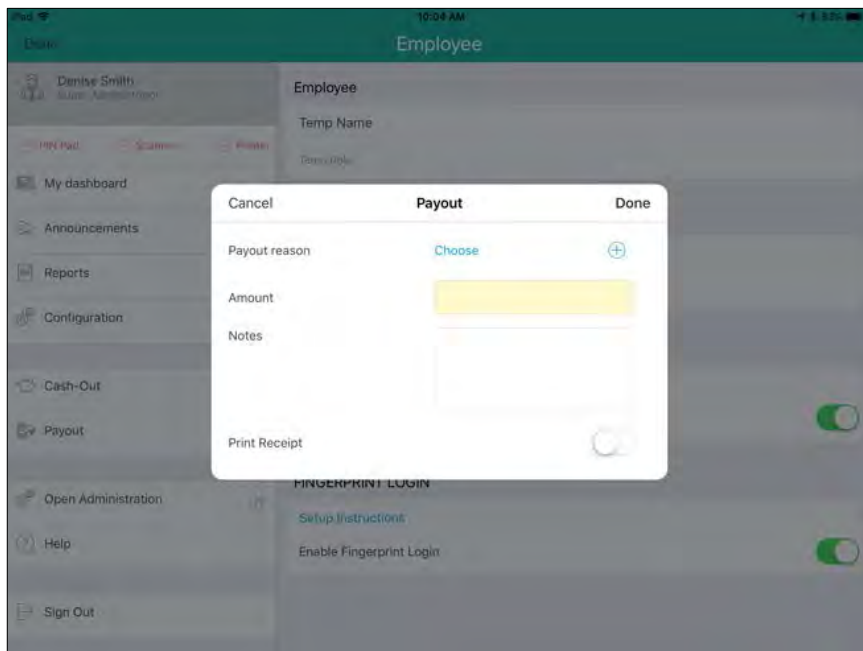

3. Do one of the following:
  - a. Tap **Choose**.

The Choose popup appears.

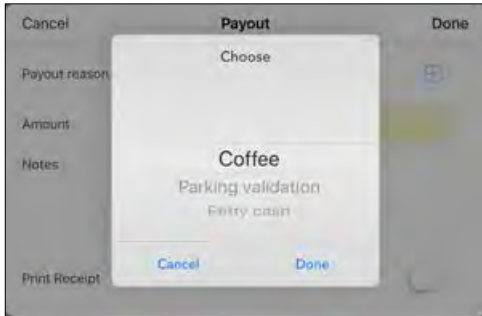

- b. In the Choose popup, select the reason for the payout and tap **Done**.
  - c. Proceed to step 4.

- a. Tap the + symbol beside **Payout reason**.

The *Payout reason* caption changes to *New reason*, and provides a text field to enter a new payout reason.

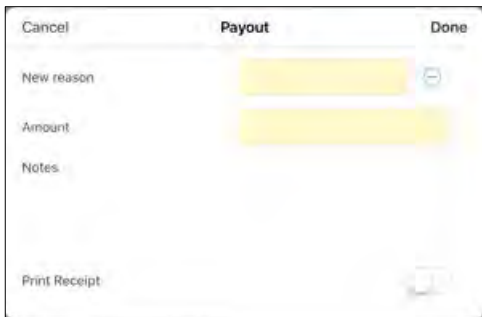

- b. Use the on-screen keyboard to enter a new payout reason.
  - c. Proceed to step 4.

4. Tap inside the **Amount** field and use the on-screen numberpad to enter the exact amount of cash being withdrawn from the till, then tap the checkmark  button.

5. (Optional) Tap inside the **Notes** field and use the on-screen keyboard to enter any applicable notes about the payout.

6. Decide on whether or not you wish to print a payout receipt:

- If you wish to print a payout receipt:
  - Toggle the **Print Receipt** switch to the right (ON). Proceed to step 7.

- If you do not wish to print a receipt:
  - Leave the **Print Receipt** switch in the OFF position. Proceed to step 7.

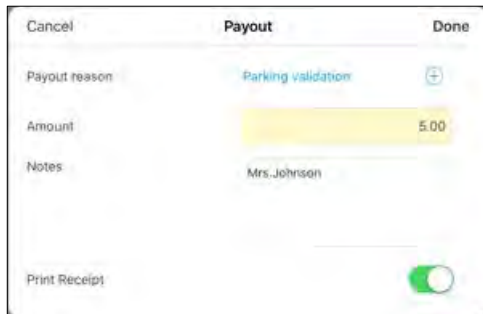

7. Tap **Done** in the top right corner of the Payout popup.  
A popup appears to indicate the payout has been created successfully, and the cash drawer opens.
8. Remove the cash from the till and tap **OK** on the popup.  
The main menu appears.
9. Repeat steps 3 – 8 to process additional payouts as necessary, or tap **Done** at the top left corner to return to the Sale screen.

## Searching transactions

Follow the steps below to search for transactions in the PAYD Pro Plus App. You can search for completed transactions, suspended transactions, pending layaways, or cancelled transactions.

1. At the bottom right corner of the Sale screen, tap **Transactions**.
2. At the top of the right pane, use the on-screen keyboard to enter your search criterion into the **Transaction Search** field. Search by:
  - **Transaction ID**
  - **Date** (in YYYY/MM/DD format)
  - Customer **name**
  - Customer **phone number**
  - Customer **email address**
3. Optional: Use the **Select Status** status selector at the top of the right pane to refine your search:
  - **All Status** – This is the default status selection, and will search for transactions of all statuses.
  - **Completed** – This will search for only completed transactions.
  - **Suspended** – This will search for only suspended transactions (refer to [Suspending a transaction](#) on page 47 for more information).
  - **Pending** – This will search for layaways that have not yet been finalized (refer to [Processing layaways](#) on page 62 for more information).
  - **Cancelled** – This will search for cancelled transactions (refer to [Cancelling transactions](#) on page 50 for more information).
4. Once the criterion is entered into the search field, tap the **Search** button on the on-screen keyboard.

**Note:** To search through all transactions, leave the search field blank and tap the **Search** button.

The results of the search appear below sorted numerically by receipt numbers.

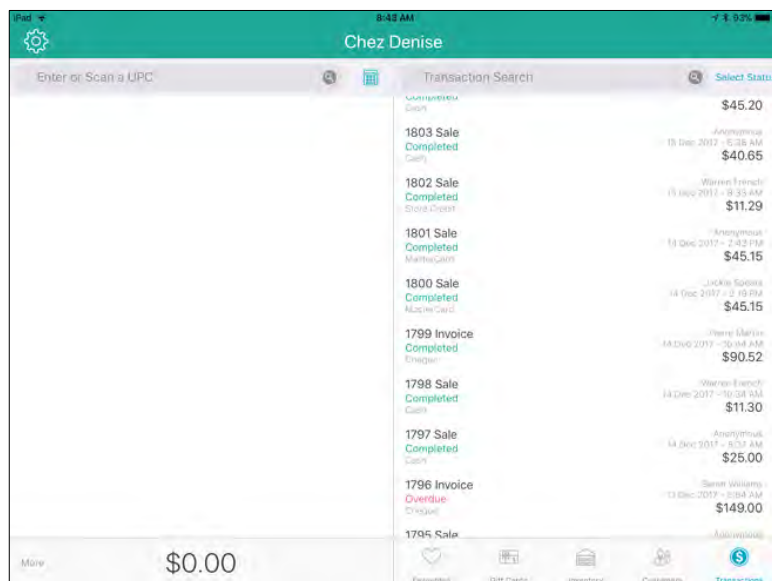



5. Tap the transaction in the results.



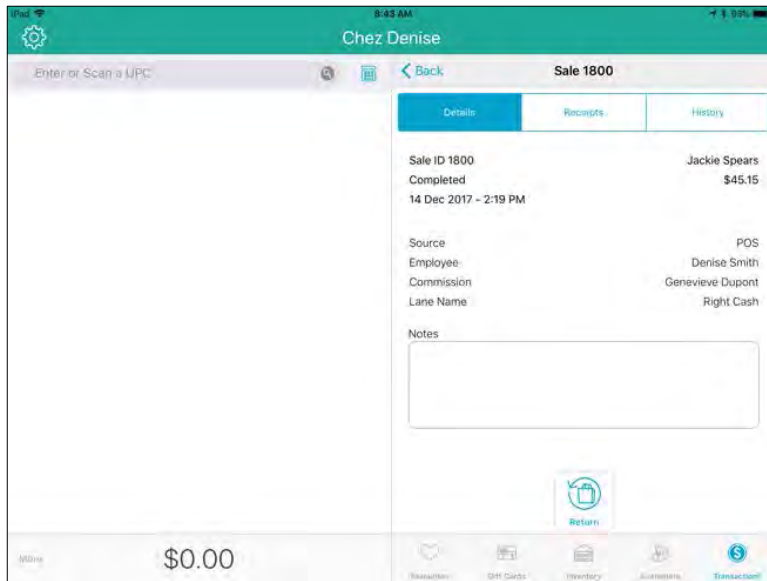

The details appear in the right pane.



6. Repeat steps 3 – 5 to search for other transactions as needed.

## Checking Bluetooth device status

Before processing transactions with the PAYD Pro Plus App, it is recommended to check the connection status of your Bluetooth devices. Ensuring they are connected before processing a transaction provides the client with a quick and seamless experience.

1. Tap the **Settings** button ()
2. At the top of the main menu, view the status of the devices.
  - A “**connected**” icon ( Printer) appears beside devices that are paired and connected to the PAYD Pro Plus App. Connected devices are ready to use immediately.
  - A “**disconnected**” icon ( Printer) appears beside items that are not paired, not powered on, or not configured in the PAYD Pro Plus App.
  - A grey icon ( Scanner) appears beside items that are not enabled in the Configuration – Devices screen.

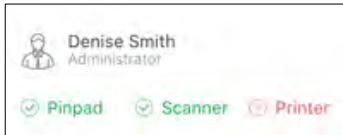

3. To connect any disconnected items:
  - Refer to the *Troubleshooting* section on page 122 for quick instructions.
  - Refer to the *PAYD Pro Plus® Mobile Solution - Hardware Install Guide* available at [moneris.com/support-PAYDProPlus-mobile](http://moneris.com/support-PAYDProPlus-mobile).

## Generating reports

There are seven reports available in the PAYD Pro Plus App. These reports provide vital financial information to you including total amounts for each tender type, total taxes collected, batch close totals, cash out totals, etc.

The list of reports includes:

Current Totals	Current Cash Totals
Previous Totals	Cash-Out Totals
Employee Daily Transactions	Product Summary
Daily Activity	

### To generate a report:

1. Tap the **Settings** button ()
2. On the main menu, tap **Reports**.
3. On the Reports screen, tap the report you wish to view.  
The report information appears in the right pane. Scroll up and down to view the information.
4. Select your output:
  - If you have a Bluetooth receipt printer, you can tap the **Print** button at the bottom of the right pane to generate a hard copy of the report.
  - If you do not have a receipt printer, you can send an email copy of the report. Tap the **Email** button at the bottom of the right pane and enter the recipient's email address, then tap **OK**.
5. Repeat step(s) 3 (and 4) as necessary for other reports.
6. Refer to the **PAYD Pro Plus Online Help** for information on the contents of the reports and their uses. Refer to [\*Accessing PAYD Administration\*](#) on page 103.

## Using the Dashboard

The PAYD Pro Plus App features a sales Dashboard, a user friendly summary of sales and business trends that allow you to view and manage your business with ease. The Dashboard provides access to real-time daily, weekly, and monthly reports summaries such as:

- **Sales** – displays total net sales as a line graph.
- **Top 3 Products** - displays the top 3 products sold based on quantity, as a circle graph.
- **Customers** - displays the transaction distribution between anonymous customers, new customers (registered today, this week, or in the selected month), and repeat customers (customers that have been registered in the past and were selected during the transaction) as a circle graph.

To access the Dashboard:

1. Tap the **Settings** button ()
2. On the main menu, tap **My dashboard**.

The Dashboard appears on the right pane.

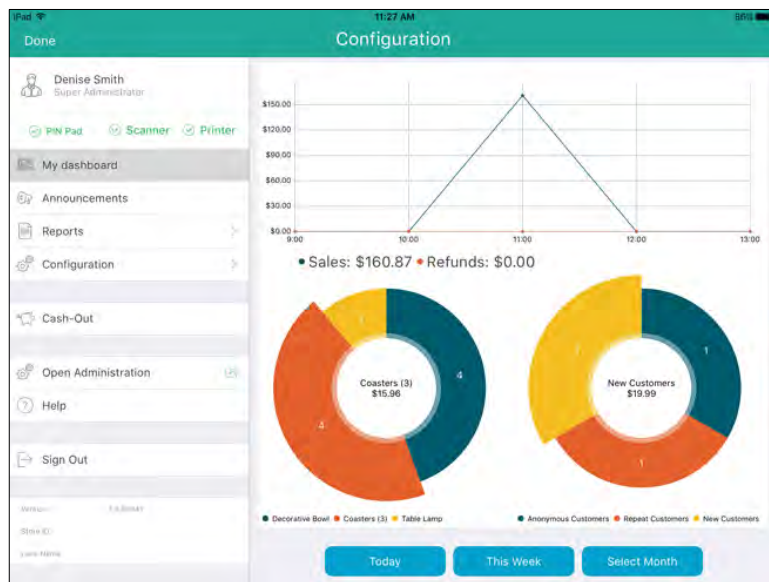

## Viewing the Dashboard data

The data that is displayed on the Dashboard is dependent upon the time frame selection that you make on the right pane. The **Today**, **This week** and **Select Month** buttons enable you to make a time frame selection, and the graphs adjust accordingly. Follow the guidelines below to determine how time frame selection changes the displayed data.

- **Today** – This is the default selection when the Dashboard is first accessed. The values displayed are as of today's calendar date from midnight to midnight.

- **This week** – Tap this button to see the values that represent the current calendar week from Monday to Sunday.

**Note:** *Due to the nature of this type of time frame, it is more valuable to view the Dashboard closer to the end of the week as viewing it early on a Monday morning would not provide any discernible data.*

- **Select Month** – When you tap this button, a month selector will appear. Scroll up/down to select a month, then tap a year, then tap the green checkmark. The displayed values are the totals for the selected month.

**Note:** *Due to the nature of this type of time frame, it is more valuable to view the Dashboard closer to the end of the month as viewing it early in the month would not provide any discernible data.*

## Processing a Return

It is possible to return a transaction in the current batch, as well as transactions from previously closed batches. Use the Return function to:

- Return a product (or multiple products) to inventory and provide the customer with a refund (or store credit accordingly).
- Return a transaction that was cashed out by mistake.
- Return a product (or multiple products) to inventory as part of an exchange.

**Note:** If the customer wishes to exchange items, process a Return first, then process a Purchase transaction for the products the customer is taking in exchange. Refer to other sections in this guide for instructions on adding items to the bill, and processing the payment and the receipts.

### To process a return:

1. At the bottom right corner of the Sale screen, tap **Transactions**.
2. Search for the transaction you wish to return (refer to [Searching transactions](#) on page 110 for more information).
3. Once you locate the transaction, tap it.

The transaction details appear.

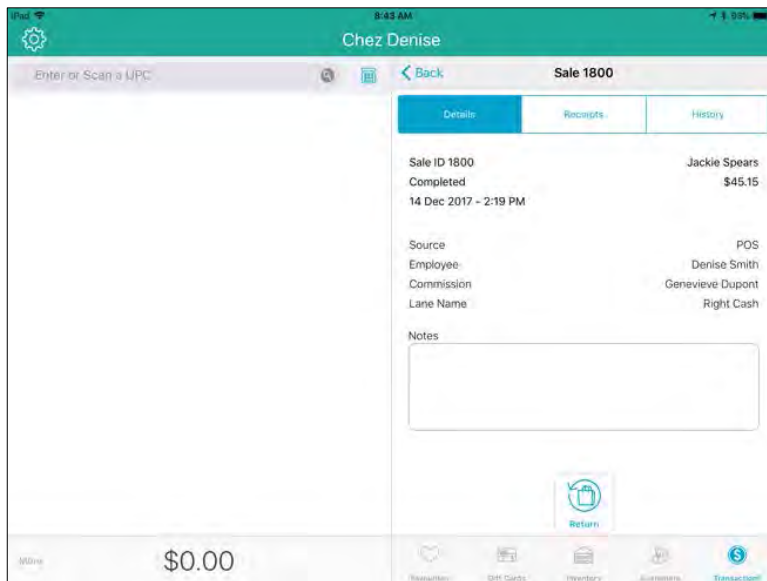

4. At the bottom of the right pane, tap the **Return** button.

The Select product(s) to return popup appears.

5. Tap the + symbol to the right of the items the customer is returning. If the customer purchased multiples of the same item, continue tapping + until every item being returned is represented in the quantity counter between the – and + buttons.
6. Repeat step 5 for other items the customer is returning as necessary.

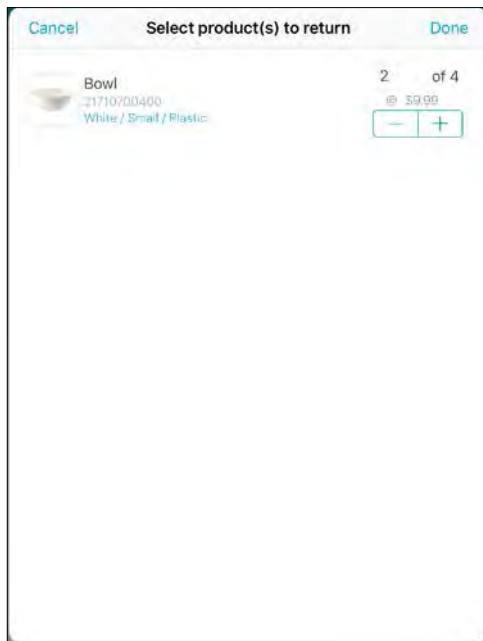

7. Tap **Done** in the top right corner of the Select product(s) to return popup to proceed with the return. In the left pane, you will see the items added in steps 5 and 6 listed as negative dollar amounts.

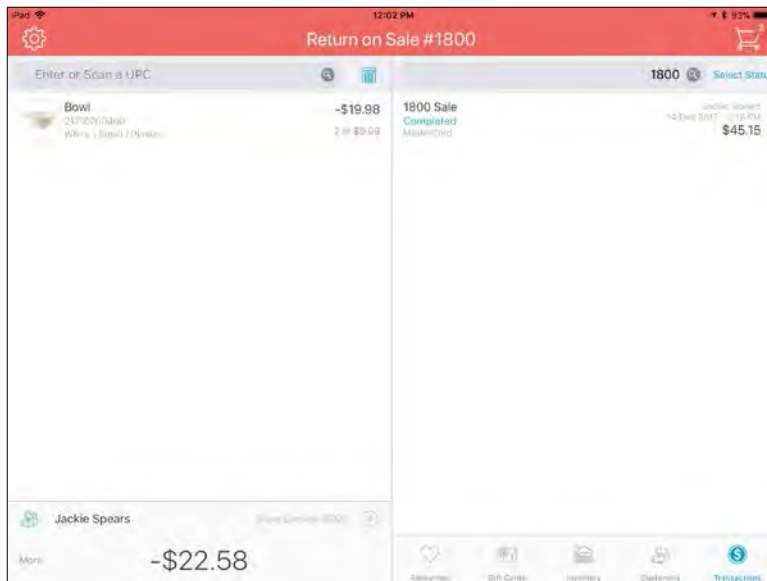

8. Tap the **Shopping Cart** button (  ) at the top of the right pane. The Checkout screen appears with the payment types on the right pane.
9. Follow the instructions below based on the tender type to which you are returning the transaction:
  - **To return to cash:**
    - a. Tap **Cash**.

- b. Review the amount of cash to return.
  - c. Tap the **OK** button.
  - d. Process receipts.
  - e. If connected to your Bluetooth receipt printer and configured, the cash drawer opens at this point.
  - f. Remove cash from the till and give it to the customer. Proceed to step 10.
- **To return a cheque:**
    - a. Tap **Cheque**.
    - b. Tap the **OK** button.
    - c. Process receipts. If connected to your Bluetooth receipt printer and configured, the cash drawer opens at this point.
    - d. Remove the cheque from the till and give it to the customer. Proceed to step 10.
  - **To return to an *Interac* Debit card (for integrated merchants only):**
    - a. Tap **Debit**.
    - b. Tap **OK**.
    - c. Swipe, tap, or insert the *Interac* Debit card on the PIN Pad.
    - d. Hand the PIN Pad to the customer.
    - e. Have the customer follow the prompts on the PIN Pad.
    - f. Process receipts.
    - g. Proceed to step 10.
  - **To return to a credit card (for integrated merchants only):**
    - a. Tap **Credit card**.
    - b. Tap **OK**.
    - c. Swipe, tap, or insert the credit card on the PIN Pad.
    - d. Hand the PIN Pad to the customer.
    - e. Have the customer follow the prompts on the PIN Pad.
    - f. Process receipts.
    - g. Proceed to step 10.
  - **To return for store credit (for an existing customer):**
    - a. Tap **Store Credit**.

The Store Credit screen appears on the right pane.
    - b. Tap **OK**.
    - c. Process receipts.



d. Proceed to step 10.

▪ **To return for store credit (for a customer who is not registered):**

a. Tap **Store Credit**.

The Assign customer popup appears.

b. Tap the **New Customer** button (.

The New Customer popup appears.

c. Tap inside the **First** and **Last Name** fields and use the on-screen keyboard to enter the customer's name.

**Note:** *If you leave the First and Last Name fields blank, the system will produce an error and you will not be able to proceed until you enter both names. You must add the customer in order to assign store credit.*

d. Tap **Done** at the top of the New Customer popup.

The Checkout screen reappears.

e. Tap **OK**.

f. Process receipts.

g. Proceed to step 10.

10. Tap **Done** to complete the return.

11. Repeat steps 2 – 10 to return other transactions as necessary.

## End of day procedures

Moneris closes your batch for you automatically at the end of each day. As an integrated merchant, you have the ability to request that Moneris perform the batch close for you daily between 10pm and 11pm EST, or you can select a time slot in which the batch close will occur.

The batch close settings can be configured in the Configuration - Settings screen in Moneris PAYD Administration. Refer to [Accessing PAYD Administration](#) on page 103 for more information.

## Cashing out

Follow the steps below to count the cash in your till.

1. Tap the **Settings** button ()
2. On the main menu, tap **Cash-Out**.

The Cash-Out screen appears.

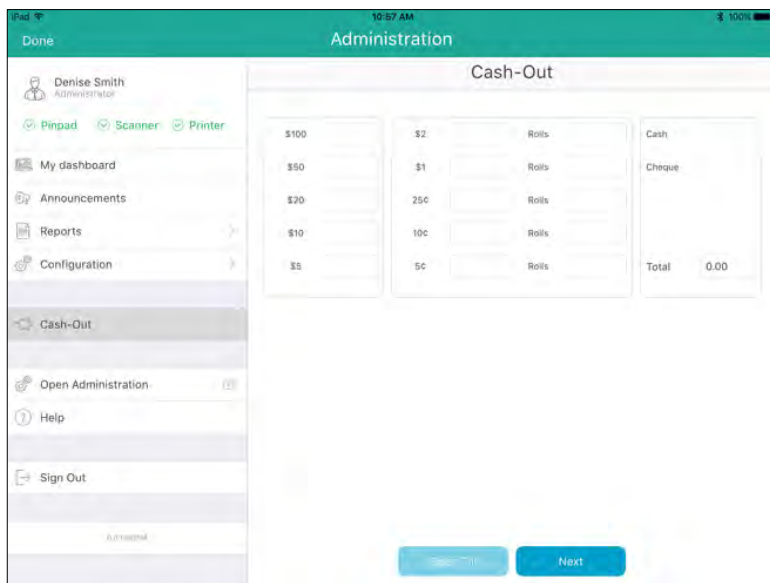

3. Count the cash in your till and use the on-screen numberpad to enter the quantities of each denomination into the appropriate field. For coins, enter any loose coins in the left field and enter any rolls into the right field for their denomination. For example, if you have 8 loose dimes and one roll of dimes, you would enter 8 into the left field and 1 into the right field of the 10 cent section.
4. Once all the fields have been filled out according to what is in your till, tap the **Next** button to proceed to the next step.
5. The next Cash-Out screen displays the Cash-Out Totals report. The results of this report show the cash counted (in the **Total Cash In Drawer (Actual)** row) and expected (in the **Closing Balance (Expected)** row), as well as amounts for any other tender types used that day.

6. Take one of the following actions:

- To go back to the previous Cash-Out screen and make changes to the amounts counted, tap **<Cash Out** at the top of the Cash-Out Totals report. Return to step 3.
- To print a copy of the Cash-Out Totals report from the Bluetooth receipt printer, tap the **Print** button. Proceed to step 7.
- To save your count and complete the cash-out procedure, tap the **Complete** button. Proceed to step 7.

7. A Cash-Out confirmation popup appears. Take one of the following actions:

- To cash in and open a new session, tap **Cash-In**. The Cash-In screen appears. Refer to the *Cashing in* section on page 8 for more information.

OR

- To sign out and end your session, tap **Sign Out**. The PAYD Pro Plus App returns to the Sign In screen. Refer to the *Signing into your PAYD Pro Plus App* section on page 6 for more information.

# Troubleshooting

## Error messages in the PAYD Pro Plus App

If an error message is displayed in the PAYD Pro Plus App (i.e., on your Apple iPad) and is listed in the table below, tap **OK** and then follow the instructions in the table's Solution column. If the problem is still not resolved, call us at **1-855-423-PAYD (7293)**.

Error message	Solution
<b>Error: The connection has failed. Please verify your network status and try again.</b>	The app does not have connection to the data. <ol style="list-style-type: none"><li>1. Close the PAYD Pro Plus App and check your Apple iPad's communication status (e.g., Wi-Fi connection).</li><li>2. If possible, restart the Apple iPad and see if you can reconnect.</li><li>3. Try signing into the PAYD Pro Plus App again (see page 6).</li></ol>
<b>The Pin is invalid.</b>	You have tried signing into the PAYD Pro Plus App with an invalid PIN. Try again with a valid PIN (see page 6).
<b>The username / password entered are invalid.</b>	You have tried signing into the PAYD Pro Plus App with an invalid username or password. Try again with a valid username and/or password (see page 6). <b>Note:</b> If you don't remember your password, you can tap <b>Forgot Password</b> and have a password reset message emailed to you.
<b>PIN Pad is not connected or paired.</b>	You have attempted to process an <i>Interac</i> Debit or credit transaction, but the PAYD PIN Pad is not connected or paired. Try the following steps first: <ol style="list-style-type: none"><li>1. Power on the PAYD PIN Pad.</li><li>2. Check the PAYD PIN Pad's status on the main menu. For more information, refer to <i>Checking Bluetooth device status</i> on page 112.</li><li>3. If neither of these suggestions work, the PAYD PIN Pad may require pairing. Refer to the pairing instructions in the <b>Moneris PAYD® PIN Pad with PAYD Pro Plus®: Quick Install Guide</b> available for free download at <a href="http://moneris.com/support-PAYDProPlus-mobile">moneris.com/support-PAYDProPlus-mobile</a>.</li></ol>
<b>"Sorry, there are no matching records"</b> when searching for products or customers.	This message appears when the search criteria entered fails to turn up any results. <ul style="list-style-type: none"><li>▪ Refine your search criteria and try again.</li></ul> If you are still unable to locate the item/customer for which you are searching, it's possible that the record for the product or customer has been deleted, or was never entered or saved in the first place.

Error message	Solution
<p><b>“Sorry, there are no matching records”</b> when searching for transactions.</p>	<p>This message appears when the search criteria entered fails to turn up any results.</p> <ul style="list-style-type: none"> <li>▪ Refine your search criteria and try again.</li> </ul> <p>If you are still unable to locate the transaction, it is possible that the transaction was cancelled before it was completed, or payment processing for that transaction was declined.</p>
<p><b>Printing Error. Please try again. Msg: Printer offline</b></p>	<p>You tried to print a transaction receipt or report, but the Bluetooth receipt printer is offline or not connected.</p> <p>Try the following steps first:</p> <ol style="list-style-type: none"> <li>1. Ensure the printer is powered on.</li> <li>2. Check the printer’s status on the main menu. For more information, refer to <a href="#">Checking Bluetooth device status</a> on page 112.</li> <li>3. If neither of these suggestions work, the printer may require pairing. Refer to the pairing instructions in the <b>PAYD Pro Plus® Mobile Solution: Hardware Install Guide</b> available at <a href="http://moneris.com/support-PAYDProPlus-mobile">moneris.com/support-PAYDProPlus-mobile</a>.</li> </ol>
<p><b>Attention!</b> <b>PIN Pad requires initialization. Cannot process a transaction until the terminal has been initialized. Remove card from the PIN Pad if present and click YES if you would like to initialize now. Click NO if you would like to do it later.</b></p>	<p>This message appears if the PIN Pad has been selected/paired within the PAYD Pro Plus App, but has not been initialized, and <b>Credit card</b> or <b>Debit</b> has been selected as a payment type. Tap <b>Yes</b> to initialize the PIN Pad.</p>
<p><b>PIN Pad connection could not be established. If this problem persists please restart the PIN Pad and Application.</b></p>	<ol style="list-style-type: none"> <li>1. Tap <b>OK</b> on the message.</li> <li>2. Logout of the PAYD Pro Plus App (see page 8) and reboot the PIN Pad.</li> <li>3. Once rebooted, log in to the App again (see page 6) and ensure the PIN Pad is connected (see page 112).</li> <li>4. If it is connected, try the transaction again.</li> </ol>
<p><b>This product is currently inactive</b></p>	<p>The product that you have attempted to add to a sale from the Favourites Group has been deactivated in PAYD Administration. Please reactivate it within PAYD Administration in order to add it to a sale.</p>

## Error messages on the PIN Pads

If an error message appears on the PIN Pad, first press the red key once or twice to clear the message, and then retry the transaction. If the error message reappears and is listed in the table below, follow the instructions in the table. If the problem is still not resolved, call us at **1-855-423-PAYD (7293)**.



Error message	Solution
<b>BATTERY CHARGING IN PROGRESS</b>	The PAYD PIN Pad battery is recharging from a very low charge level. Wait for the WELCOME/BONJOUR screen to display before you attempt to perform a transaction (this may take several minutes).
<b>CANNOT SWIPE CHIP CARD</b>	Insert the chip card into the PIN Pad's chip card reader.
<b>CARD BLOCKED REMOVE CARD</b>	The chip card cannot be used. Ask for another form of payment.
<b>CARD NOT SUPPORTED PLEASE RETRY</b>	Swipe the card again. If this does not work, request another form of payment.
<b>CARD PROBLEM</b>	Retry the transaction. If the message reappears: <ul style="list-style-type: none"> <li>▪ If card was inserted: <ul style="list-style-type: none"> <li>▪ Swipe the card.</li> </ul> </li> <li>▪ If credit card was swiped: <ul style="list-style-type: none"> <li>▪ Manually enter the card (see page 56).</li> </ul> </li> <li>▪ If debit card was swiped: <ul style="list-style-type: none"> <li>▪ Request another form of payment.</li> </ul> </li> </ul>
<b>CARD READ ERR</b>	The card data could not be read when the card was swiped or tapped. Retry the transaction.
<b>CONTACTLESS TRANSACTION LIMIT EXCEEDED</b>	If the card has a chip, insert it into the chip reader; otherwise, swipe the card.
<b>DECLINED BY CARD</b>	The chip card has declined the transaction. Retrieve the PIN Pad, and remove the chip card. Request another form of payment.
<b>ERROR CARD REMOVED</b>	The chip card was removed during the transaction. Retrieve the PIN Pad, and retry the transaction.
<b>MUST INSERT CARD</b>	If the card has a chip, insert it into the chip reader; otherwise, swipe the card.
<b>NO CARD</b>	The card was not entered on the PIN Pad in the required time.

Error message	Solution
<b>NO SUPPORTED APPLICATIONS REMOVE CARD</b>	<ul style="list-style-type: none"> <li>▪ If card inserted: <ul style="list-style-type: none"> <li>▪ Remove the card from the chip reader, and swipe it when prompted.</li> </ul> </li> <li>▪ If card tapped: <ul style="list-style-type: none"> <li>▪ If it has a chip, insert it into the chip reader; otherwise, swipe the card.</li> </ul> </li> </ul>
<b>NOT ACCEPTED REMOVE CARD</b> or <b>NOT ACCEPTED USE MAG STRIPE REMOVE CARD</b>	Remove the chip card from the chip reader. If prompted, swipe the card on the magnetic stripe reader. <ul style="list-style-type: none"> <li>▪ <b>Credit only:</b> <ul style="list-style-type: none"> <li>▪ If this does not work, manually enter the card number (see page 56).</li> </ul> </li> <li>▪ <b>Debit only:</b> <ul style="list-style-type: none"> <li>▪ Ask for another form of payment.</li> </ul> </li> </ul>
<b>NOT COMPLETED</b>	The customer took more than 30 seconds to respond to the prompts. Retry the transaction.
<b>PLEASE CHARGE THE TERMINAL</b>	The PAYD PIN Pad's battery charge is low. Connect the PAYD PIN Pad to an external power source via the USB charging cable. When "BATTERY CHARGING IN PROGRESS" appears, refer to that message in this table.
<b>REFUND LIMIT EXCEEDED</b>	The total value of Refunds performed today is greater than your daily Refund Limit. <ol style="list-style-type: none"> <li>1. Contact Moneris Customer Care at <b>1-855-423-PAYD (7293)</b> for a temporary increase in your daily Refund Limit.</li> <li>2. Ensure that you have the original Purchase receipt available for reference.</li> </ol>
<b>TAP NOT ACCEPTED</b>	<ol style="list-style-type: none"> <li>1. Cancel the transaction.</li> <li>2. Ensure that the PAYD PIN Pad battery has a charge level of at least 50% and retry the transaction.</li> <li>3. If the issue recurs, insert the card into the chip reader if the card has a chip; otherwise, swipe the card.</li> </ol>
<b>WRONG CARD TYPE</b>	The card that was swiped cannot be used for this transaction. Ask for another card and retry.

## Other issues (PIN Pads)

Issue	Solution
<p><b>The PAYD PIN Pad and/or PAYD Pro Plus App stalls or freezes midway during a transaction.</b></p>	<ol style="list-style-type: none"> <li>1. If the card is inserted, remove it from the chip reader.</li> <li>2. Close/shutdown the PAYD Pro Plus App.</li> <li>3. Power off the PAYD PIN Pad and then power it on again.</li> <li>4. Re-launch the PAYD Pro Plus App, and sign in (see page 6).</li> <li>5. Retry the transaction.</li> </ol>
<p><b>The screen on the PAYD PIN Pad displays the hardware manufacturer name/logo instead of WELCOME/BONJOUR.</b></p>	<p>The PAYD PIN Pad is in Sleep mode.</p> <p>Press the Power button to wake the PAYD PIN Pad and return it to the WELCOME/BONJOUR screen.</p> <p>To prevent the PAYD PIN Pad from going into Sleep mode and/or powering off when not connected to an external power source, refer to the <b>Moneris PAYD® PIN Pad with PAYD Pro Plus®: Quick Install Guide</b> available for free download at <a href="https://moneris.com/support-PAYDProPlus-mobile">moneris.com/support-PAYDProPlus-mobile</a>.</p>
<p><b>The PAYD PIN Pad powers off.</b></p>	<p>The PAYD PIN Pad may have gone into Sleep mode and then shut down to conserve power.</p> <p>To power on the PAYD PIN Pad, press the PAYD PIN Pad's Power button.</p> <p>If this does not work (the battery charge may be depleted), connect the PAYD PIN Pad to an external power source via the USB charging cable.</p> <p>To prevent the PAYD PIN Pad from going into Sleep mode and/or powering off when not connected to an external power source, refer to the <b>Moneris PAYD® PIN Pad with PAYD Pro Plus®: Quick Install Guide</b> available for free download at <a href="https://moneris.com/support-PAYDProPlus-mobile">moneris.com/support-PAYDProPlus-mobile</a>.</p>
<p><b>The contactless reader does not beep when a card is tapped/waved at the “SWIPE, TAP OR INSERT CARD” prompt.</b></p>	<p>The PAYD PIN Pad battery charge level may be too low. See the solution for “TAP NOT ACCEPTED” on page 125.</p>



Issue	Solution
<p><b>PIN Pad initialization error.</b></p>	<p>There was a problem initializing the iPP320 PIN Pad.</p> <ol style="list-style-type: none"> <li>1. Tap <b>OK</b> on the error message.</li> <li>2. Sign out of the PAYD Pro Plus App (refer to <i>Signing out</i> on page 8 for more information).</li> <li>3. Power cycle the iPP320 PIN Pad: <ul style="list-style-type: none"> <li>▪ Hold down the yellow  key and press the punctuation  key. The PIN Pad will restart.</li> </ul> </li> <li>4. Once the WELCOME/BONJOUR screen appears on the PIN Pad, log in to the PAYD Pro Plus App (see page 6).</li> <li>5. Tap the <b>Settings</b> button ().</li> <li>6. On the main menu, tap <b>Configuration</b>.</li> <li>7. In the Configuration screen, tap <b>Devices</b>.</li> <li>8. In the <b>PIN PAD</b> section, tap <b>Initialize</b>, and at the warning prompt, tap <b>Yes</b>.</li> </ol> <p>The PIN Pad should initialize.</p> <p>If the above steps do not work, contact Moneris Customer Care toll-free at <a href="tel:1-855-423-PAYD">1-855-423-PAYD (7293)</a>.</p>



# Merchant support

At Moneris, help is always here for you 24/7.

# If you need assistance with your payment processing solution, we're here to help, 24/7.

We're only one click away.

- To access the **PAYD Pro Plus Online Help** tool:
  - For context-sensitive help from within PAYD Administration, click the **Help** icon ()
  - For the full webhelp, from within a context-sensitive help window, tap the '**Show**' link in the top left corner of the window. The full webhelp table of contents will appear on the left side of the window.
- Visit [moneris.com/support-PAYDProPlus-mobile](https://moneris.com/support-PAYDProPlus-mobile) to:
  - consult the FAQs on how to set up and use PAYD Pro Plus
  - download PAYD Pro Plus guides to assist with getting started, hardware installation, configuration, and usage instructions
- Visit [shop.moneris.com](https://shop.moneris.com) to purchase point-of-sale supplies and receipt paper
- Visit [moneris.com/insights](https://moneris.com/insights) for business and payment news, trends, customer success stories, and quarterly reports & insights

## Need us on-site? We'll be there.

Moneris offers quick, hassle-free on-site setup of your complete iPad POS Solution by our in-house technicians. Contact us at **1-866-MONERIS** or visit [moneris.com/iPadPOS](https://moneris.com/iPadPOS) to learn more.

## Can't find what you are looking for?

Call Moneris Customer Care (available 24/7) toll-free at **1-866-319-7450**. We'll be happy to help. You can also send us a secure message 24/7 by logging in to Merchant Direct at [moneris.com/mymerchantdirect](https://moneris.com/mymerchantdirect).



---

**BE PAYMENT READY**

MONERIS, MONERIS BE PAYMENT READY & Design and MERCHANT DIRECT are registered trade-marks of Moneris Solutions Corporation. MONERIS PAYD, PAYD, PAYD PRO and PAYD PRO PLUS are registered trade-marks of Moneris Solutions Corporation. APPLE, IPAD are trade-marks of Apple Inc., registered in the U.S. and other countries. BLUETOOTH is a registered trade-mark of Bluetooth SIG, Inc. INTERAC is a registered trade-mark of Interac Inc. All other marks or registered trade-marks are the property of their respective owners.

© 2018 Moneris Solutions Corporation, 3300 Bloor Street West, Toronto, Ontario, M8X 2X2. All Rights Reserved. This document shall not wholly or in part, in any form or by any means, electronic, mechanical, including photocopying, be reproduced or transmitted without the authorized consent of Moneris Solutions Corporation.

This document is for informational purposes only. Neither Moneris Solutions Corporation nor any of its affiliates shall be liable for any direct, indirect, incidental, consequential or punitive damages arising out of use of any of the information contained in this document. Neither Moneris Solutions Corporation or any of its affiliates nor any of our or their respective licensors, licensees, service providers or suppliers warrant or make any representation regarding the use or the results of the use of the information, content and materials contained in this document in terms of their correctness, accuracy, reliability or otherwise. This document has not been authorized, sponsored, or otherwise approved by Apple Inc.

Your gift card processing is governed by your agreement for gift card services with Moneris Solutions Corporation. Your credit and/or debit card processing is governed by the terms and conditions of your agreement for PAYD credit/debit card processing services with Moneris Solutions Corporation. It is your responsibility to ensure that proper card processing procedures are followed at all times. Please refer to the ***Moneris Merchant Operating Manual*** (available at: [moneris.com/support](https://moneris.com/support)) and the terms and conditions of your applicable agreement(s) for credit/debit processing or other services with Moneris Solutions Corporation for details.